

KFN 7785 C

Built-in fridge-freezer combination

FlexiLight 2.0, Freeze&Cool, NoFrost and Mylce for individual convenience.



- Spacious drawer with moisture control – DailyFresh
- Flexible use of freezer – Freeze&Cool
- Ice cubes with My Ice with water container
- Individually adjustable glass shelf lighting with FlexiLight 2.0
- No icing up of food and no need to defrost thanks to NoFrost



EAN: 4002516748212 / Material number: 12445200 / Old Material Number: 38778505EU1

Appliance category	
Fridge-freezer	•
Construction type	
Built-in appliance	•
Integrated appliance	•
Door hinge	right
Convertible door hinging	•
Design	
Refrigeration section lighting	FlexiLight 2.0
Freezer compartment lighting	LED
Fan lighting	•
IceMaker lighting	•
User convenience	
Networking with Miele@home	•
Freshness system	DailyFresh
Freeze & Cool	•
Fine adjustment inner door	•
ComfortClean	•
DynaCool	•
NoFrost	•
DuplexCool	•
VarioRoom	•
SoftClose	•
Ice cube maker with water container (Mylce)	•
Control system	
Operating concept	FreshTouch
Fridge compartment can be switched off	Yes
Independent temperature regulation of fridge and freezer zones	Yes
Automatic SuperCool	•
SuperFreeze	•
No. of temperature zones	2
Sabbath mode	•
Party mode	•
Holiday mode	•
Fridge/Fridge section	
No. of shelves	4
of which illuminated	2
No. of crisper drawers	1
Dry back wall	CleanSteel
FlexiTray	•
Number of inner door racks for tinned food	3
Door rack for bottles	1
Door shelves	4
Freezer/Freezer section	
Number of freezer drawers	3
of which on runners	2
Efficiency and sustainability	
Energy efficiency class (A–G)	C
Annual energy consumption in kWh	146.00

KFN 7785 C

Built-in fridge-freezer combination

FlexiLight 2.0, Freeze&Cool, NoFrost and Mylce for individual convenience.



EAN: 4002516748212 / Material number: 12445200 / Old Material Number: 38778505EU1

Energy consumption in 24 h in kWh	0.40
Safety	
Lock function	•
Acoustic door alarm	•
Acoustic temperature alarm	•
Optical door alarm	•
Optical temperature alarm	•
Power cut indication for freezer section	•
Technical data	
Niche width in mm min.	560
Niche width in mm max.	570
Niche height in mm min.	1772
Niche height in mm max.	1788
Niche depth in mm	550
Appliance width in mm	559
Appliance height in mm	1770
Appliance depth in mm	546
Weight in kg	73.0
Door hinge technology	Fixed door
Max. door front weight – refrigerator, in kg	18
Max. door front weight – freezer, in kg	12
Climate class	SN-T
Refrigerator compartment in l	184
4* freezer compartment in l	71
Total usable capacity in l	255
Storage time in case of fault in h	9
Freezer capacity in kg/24 h	6.00
Acoustic airborne noise emission class (A–D)	B
Sound emissions in dB(A) re 1 pW	33
Current consumption (mA)	1400
Voltage in V	220-240
Fuse rating in A	10
Number of phases	1
Frequency in Hz	50-60
Length of supply lead in m	2.2
Replacing lamps	Service
Accessories included	
Egg tray	•

KFN 7785 C

Built-in fridge-freezer combination

FlexiLight 2.0, Freeze&Cool, NoFrost and Mylce for individual convenience.

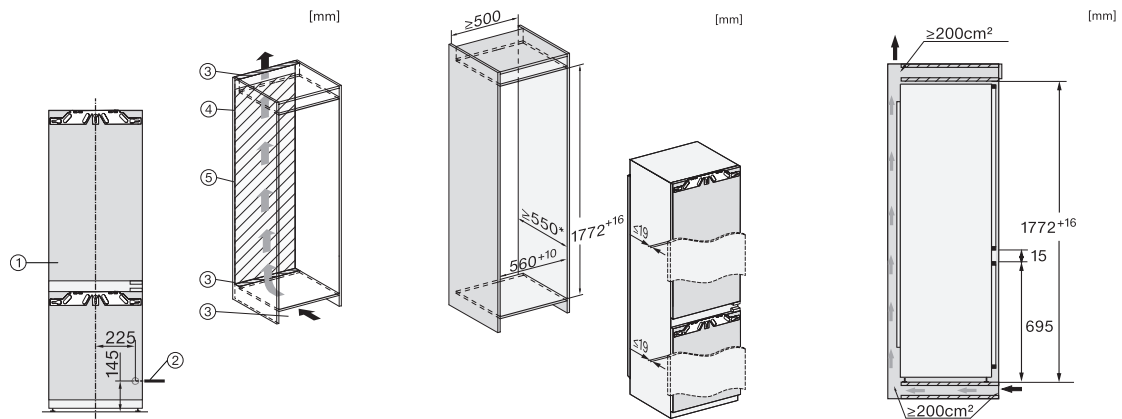

KFN7734C, KFN7734F, KFN7734D, KFN7764D, KFN7785D, KFN7744E, KFN7774D, installation (footnote*) (installation drawings)

*1. View from the front, 2. Mains connection cable, L = 2100 mm, 3. Ventilation cut-out min. 200 cm², 4. Ventilation, 5. No connections permitted in this area

KFN7734C, KFN7734F, KFN7734D, KFN7764D, KFN7785D, KFN7744E, KFN7774D, built-in (footnote*) (installation drawings)

*The declared energy consumption was calculated in a 560 mm deep niche. The appliance is fully functional in a 550 mm niche but the energy consumption will be slightly higher.

KFNS7734D, KFN7734C, KFN7734F, KFN7734D, KFN7764D, KFN7785D, KFN7744E, KFN7774D, side view (installation drawings)