



User Guide

Quality, Design and Innovation

























home.liebherr.com/fridge-manuals



LIEBHERR

Contents

1	Appliance at a glance.....	3
1.1	Scope of delivery.....	3
1.2	Overview of the appliance and its equipment.....	3
1.3	SmartDevice.....	3
1.4	Appliance range of use.....	4
1.5	Conformity.....	4
1.6	SVHC substances according to REACH regulation.....	4
1.7	EPREL database.....	4
2	General safety instructions.....	4
3	Putting into operation.....	6
3.1	Switching on appliance.....	6
3.2	Inserting the components.....	6
4	Foods management.....	6
4.1	Storing food.....	6
4.2	Storage times.....	7
5	Saving energy.....	7
6	Controls.....	7
6.1	Controls and displays.....	7
6.1.1	Status display.....	7
6.1.2	Navigation.....	8
6.1.3	Operating structure.....	8
6.1.4	Display symbols.....	8
6.2	Control concept.....	8
6.2.1	Activating/deactivating the function.....	8
6.2.2	Selecting function value.....	9
6.2.3	Activating/deactivating settings.....	9
6.2.4	Selecting the setting value.....	9
6.2.5	Go to the Customer menu.....	9
6.3	Functions.....	10
	Turn off appliance.....	10
	WiFi.....	10
	Temperature.....	11
	D-Value*.....	11
	SuperCool.....	11
	PowerCool.....	11
	SuperFrost.....	11
	PartyMode.....	12
	HolidayMode.....	12
	SabbathMode.....	12
	E-Saver.....	13
	IceMaker*.....	13
	Ice cubes*.....	13
	MaxIce*.....	13
	TubeClean*.....	14

	CleaningMode*.....	14
	Display brightness.....	14
	Door alarm.....	14
	Entry lock.....	14
	Info.....	14
	Reminder.....	14
	Reset.....	15
6.4	Fault messages.....	15
6.4.1	Warnings.....	15
6.4.2	Message.....	15
6.4.3	DemoMode.....	15
7	Features.....	15
7.1	Door rack.....	15
7.2	Shelves.....	16
7.3	Dividing shelf*.....	16
7.4	VarioSafe*.....	17
7.5	Space for baking tray.....	17
7.6	Drawers.....	17
7.7	EasyFresh-Safe cover.....	19
7.8	Adjusting the moisture levels.....	19
7.9	Glass shelves.....	19
7.10	IceMaker*.....	20
7.11	VarioSpace.....	21
7.12	Accessories.....	21
8	Maintenance.....	21
8.1	FreshAir carbon filter.....	21
8.2	Disassembling / assembling pull-out systems.....	22
8.3	Defrosting the appliance.....	22
8.4	Cleaning the appliance.....	23
9	Customer help.....	24
9.1	Technical specifications.....	24
9.2	Operating noises.....	24
9.3	Technical fault.....	25
9.4	Customer Services.....	26
9.5	Model plate.....	26
10	Shutting down.....	27
11	Disposal.....	27
11.1	Preparing appliance for disposal.....	27
11.2	Disposing of the appliance in an environmentally friendly manner.....	27

The manufacturer is continually working on the further development of all types and models. Please be aware that we reserve the right to make changes to the shape, equipment and technology.

Symbol	Explanation
	Read instructions Please read the information in these instructions carefully to understand all of the benefits of your new appliance.

Symbol	Explanation
	<p>Full instructions on the internet</p> <p>You can find detailed instructions on the internet using the QR code on the front of these instruction or by entering the service number at home.liebherr.com/fridge-manuals.</p> <p>The service number can be found on the serial tag:</p> <p style="text-align: center;"><i>Fig. Example illustration</i></p>
	<p>Check appliance</p> <p>Check all parts for transport damage. If you have any complaints, please contact your agent or customer service.</p>
	<p>Differences</p> <p>These instructions apply to a range of models, so differences are possible. Sections that apply to certain models only are marked with an asterisk (*).</p>
	<p>Instructions and results</p> <p>Instructions are marked with a ▶.</p> <p>Results are marked with a ▷.</p>
	<p>Videos</p> <p>Videos about the appliances are available on the YouTube channels of Liebherr-Hausgeräte.</p>

These operating instructions apply to:

ICd / e	51..
ICNc / d / e / f	51..
ICNSe / f	51..

Note

If your appliance has an N in its appliance designation, it is a NoFrost appliance.*

1 Appliance at a glance

1.1 Scope of delivery

Check all parts for damage during transport. If you have any complaints, please contact your retailer or Customer Services (see 9.4 Customer Services).

Your new appliance comes with the following parts:

- Built-in appliance
- Features (depending on the model)
- Installation materials (depending on the model)
- "Quick Start Guide"
- "Installation Guide"
- Service Brochure

1.2 Overview of the appliance and its equipment

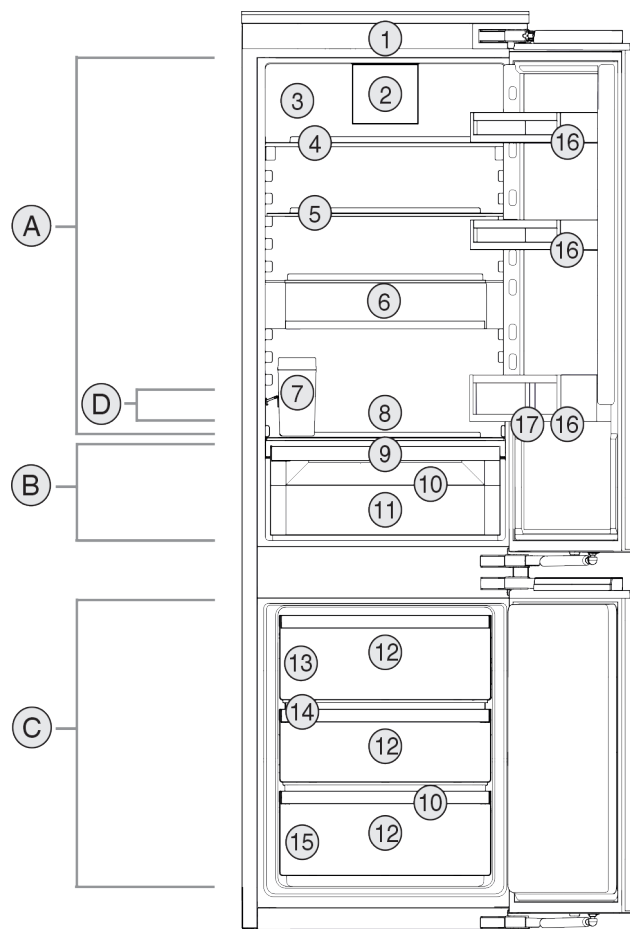

Fig. 1 Example illustration

Temperature range

- (A) Fridge section
- (B) EasyFresh
- (D) Coldest zone
- (C) Freezer compartment

Features

- (1) Controls
- (2) Fan with FreshAir active carbon filter
- (3) Dry rear wall*
- (4) Split shelf*
- (5) Shelf
- (6) VarioSafe*
- (7) IceMaker water tank*
- (8) Space for baking tray
- (9) Lid for EasyFresh-Safe
- (10) Drainage outlet
- (11) EasyFresh-Safe
- (12) Freezer compartment
- (13) IceMaker*
- (14) VarioSpace
- (15) Nameplate
- (16) Door rack
- (17) Bottle rack

Note

▶ Shelves, drawers and baskets are arranged for optimum energy efficiency when the appliance is delivered. Changing how the shelves, for example, are inserted in the fridge compartment does not have any impact on energy consumption.

1.3 SmartDevice

SmartDevice is the networking solution for your fridge-freezer.

If your appliance SmartDevice-enabled or compatible, you can quickly and easily connect your appliance to your WiFi. With the SmartDevice app, you can operate your appliance from a mobile device. Additional functions and setting options are available in the SmartDevice SmartDevice app.

General safety instructions

SmartDevice-compatible appliance:

Your appliance is compatible for use with the SmartDeviceBox. You must first purchase and install the SmartDeviceBox. In order to connect your appliance to the WiFi, you need to download the SmartDevice app.



More information about SmartDevice: smartdevice.liebherr.com

Purchasing the SmartDeviceBox in the Liebherr-Hausgeräte store: home.liebherr.com/shop/de/deu/smartdevicebox.html

Downloading the SmartDevice app:



After installing and configuring the SmartDevice, you can connect your appliance to the WiFi using the SmartDevice app and the WiFi appliance function (see WiFi).

Note

You cannot use the SmartDeviceBox in the following countries: Belarus, Kazakhstan, Russia. The SmartDevice function is not available.

1.4 Appliance range of use

Intended use

The appliance is only suitable for cooling food products in a domestic or household-like environment. This includes, for example, use:

- in staff kitchens, bed and breakfast establishments,
- by guests in country houses, hotels, motels and other accommodation,
- for catering and similar services in the wholesale trade.

All other types of use are not permitted.

Foreseeable misuse

The following applications are expressly forbidden:

- Storing and refrigerating medicines, blood plasma, laboratory preparations or similar substances and products based on the Medical Device Directive 2007/47/EC
- Use in areas at risk of explosions

Misusing the appliance may lead to damage to the goods stored or they may spoil.

Climate classifications

Depending on the climate classification the appliance is designed to operate in restricted ambient temperatures. The climate classification applying to your appliance is printed on the rating plate.

Note

► Keep to the specified ambient temperatures in order to guarantee that the appliance works properly.

Climate classification	for ambient temperatures of
SN	10 °C to 32 °C
N	16 °C to 32 °C
ST	16 °C to 38 °C
T	16 °C to 43 °C
SN-ST	10 °C to 38 °C
SN-T	10 °C to 43 °C

1.5 Conformity

The refrigerant circuit has been tested for leaks. When installed, the appliance complies with the applicable safety regulations and with the corresponding directives.

The full text of the EU Declaration of Conformity is available on the following website: www.Liebherr.com

1.6 SVHC substances according to REACH regulation

You can check whether your appliance contains SVHC substances according to REACH regulation at the following link: home.liebherr.com/de/deu/de/liebherr-erleben/nachhaltigkeit/umwelt/scip/scip.html

1.7 EPREL database

Details about energy labelling and ecodesign requirements will be available on the European product database (EPREL) from 1st March 2021. You can access the product database at the following link: <https://eprel.ec.europa.eu/> You will be asked to enter the model ID. You can find the model ID on the nameplate.

2 General safety instructions

Please keep these operating instructions in a safe place so you can refer back to them at any time.

If you pass the appliance on, please hand these operating instructions to the next user.

Read these operating instructions carefully before use to ensure safe and correct use of the appliance. Follow the instructions, safety instructions and warning messages included at all times. They are important for ensuring you can operate and install the appliance safely and without any problems.

Danger for the user:

- This device can be used by children and people with impaired physical, sensory or mental abilities or with a lack of experience and knowledge provided that they are supervised or have received instruction in the safe use of this device, and about the resulting hazards. Children must not play with this appliance. Cleaning and user maintenance work must not be carried out by children without adult supervision. Children aged between 3 and 8 are allowed to load and unload the appliance. Children below the age of 3 must be kept away from the appliance unless they are under continuous adult supervision.
- The socket must be easily accessible so that the appliance can be disconnected quickly from the electricity in an emergency. It must not be located in the area behind the appliance.
- When disconnecting the appliance from the supply, always take hold of the plug. Do not pull the cable.
- In the event of a fault pull out the mains plug or deactivate the fuse.
- Do not damage the mains power cable. Do not operate the appliance with a defective mains power cable.
- Only customer service or other specially trained staff may repair or perform other operations on the appliance.
- Only install, connect and dispose of the appliance according to the instructions.
- Only use the appliance when is installed.

Fire hazard:

- The coolant used (information on the model plate) is ecofriendly but also flammable. Any leaking coolant may ignite.
 - Do not damage the refrigerant circuit pipes.
 - Do not handle ignition sources inside the appliance.
 - Do not use electrical appliances inside the appliance (e.g. steam cleaners, heaters, ice cream makers, etc.).
 - If the refrigerant leaks: remove any naked flames or ignition sources from the vicinity of the leakage point. Properly air the room. Inform customer services.
- Do not store explosives or sprays using combustible propellants such as butane, propane, pentane, etc. in the appliance. To identify these spray cans, look for the list of contents printed on the can, or a flame

symbol. Gases possibly escaping may ignite due to electrical components.

- Keep burning candles, lamps and other items with naked flames away from the appliance so that they do not set the appliance on fire.
- Please be sure to store alcoholic drinks or other packaging containing alcohol in tightly closed containers. Any alcohol that leaks out may be ignited by electrical components.

Danger of tipping and falling:

- Do not misuse the plinth, drawers, doors etc. as a step or for support. This applies particularly to children.

Danger of food poisoning:

- Do not consume food which has been stored too long.

Danger of frostbite, numbness and pain:

- Avoid prolonged skin contact with cold surfaces or refrigerated/frozen goods or take protective measures, e.g wear gloves.

Danger of injury and damage:

- Hot steam can lead to injury. Do not use electrical heating or steam cleaning equipment, open flames or defrosting sprays to defrost.
- Do not use sharp implements to remove the ice.

Risk of crushing:

- Do not hold the hinge when opening and closing the door. Fingers may get caught.

Symbols on the appliance:



This symbol may be located on the compressor. It relates to the oil in the compressor and makes reference to the risk that: Swallowing or inhaling can be fatal. This advice is only relevant to recycling. There is no danger in normal operation.



This symbol is located on the compressor and indicates the danger of flammable materials. Do not remove the sticker.



This or a similar sticker may be located on the rear of the appliance. This sticker indicates that there are vacuum insulation panels (VIP) or perlite panels in the door and/or housing. This advice is only relevant to recycling. Do not remove the sticker.

Please note the warning messages and other specific advice in the other chapters:

Putting into operation

	DANGER	indicates an immediately hazardous situation which will lead to death or serious injuries if it is not avoided.
	WARNING	indicates a hazardous situation which may lead to death or serious injuries if it is not avoided.
	CAUTION	indicates a hazardous situation which may lead to minor or moderate injuries if it is not avoided.
	NOTICE	indicates a hazardous situation which may lead to damage to property if it is not avoided.
	Note	indicates useful instructions and tips.

3 Putting into operation

3.1 Switching on appliance

Ensure that the following conditions are met:

- Appliance is installed and connected according to installation instructions.
- All adhesive strips, adhesive and protective films as well as transport safety devices in and on the appliance are removed.
- All marketing leaflets are removed from the drawers.

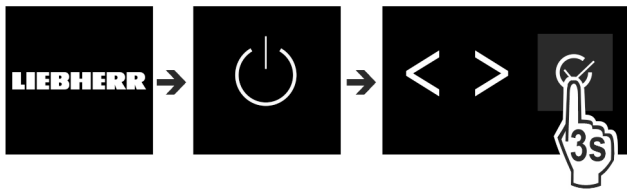

Fig. 2

- ▶ Switch on the appliance using the control panel next to the display.
- ▷ The status display appears.

The appliance starts in DemoMode:

If the appliance starts in DemoMode, you can deactivate DemoMode within the next 5 minutes.

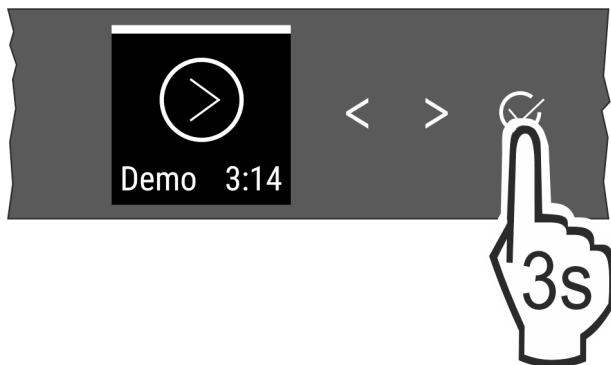

Fig. 3

- ▶ Press Confirm next to the display for 3 seconds.
- ▷ DemoMode is deactivated.

Note

The manufacturer recommends:

- ▶ Place the food inside: Wait for around 6 hours until the set temperature is reached.
- ▶ **Store frozen foods** at -18 °C or colder.

3.2 Inserting the components

Note

Accessories can be purchased from the Liebherr-Hausgeräte store at home.liebherr.com/shop/de/deu/zubehor.html.

- ▶ Insert the supplied components to make the most of your appliance.

4 Foods management

4.1 Storing food



WARNING

Risk of fire

- ▶ Do not use any electrical appliances in the food area of the appliance unless recommended by the manufacturer.

Note

The energy consumption increases and the cooling power goes down if ventilation is not sufficient.

- ▶ Always keep air slots clear.

When storing food, always observe the following:

- Air vents on the inside rear wall are unobstructed.
- Air vents on the fan are unobstructed.
- Food is in sealed packaging.
- Foods that easily absorb or give off smell or taste are stored in sealed containers or covered.
- Raw meat and fish are in clean, sealed containers to prevent them coming into contact with or dripping onto other foods.
- Liquids are in sealed containers.
- Foods are not stored too closely together, as the air needs to circulate.

Note

Failure to follow these guidelines can lead to food perishing.

4.1.1 Fridge section

The natural air circulation creates a range of temperatures.

Arrange your food as follows:

- ▶ In the top section and in the door: butter and cheese, preserves and tubes.
- ▶ In the coldest zone Fig. 1 (D): Perishable foods such as ready-to-eat meals, meat and sausages
- ▶ On the bottom shelf: Raw meat and fish

4.1.2 EasyFresh-Safe

This compartment is great for non-packaged foods, such as fruit and vegetables.

The air moisture in the compartment depends on the moisture content of the items being stored and the number of times the door is opened. You can adjust the air moisture.

Arrange your food as follows:

- ▶ Store your loose fruit and vegetables.
- ▶ Excessive air moisture: Regulate the air humidity (see 7.8 Adjusting the moisture levels).

4.1.3 Freezer compartment

This provides a dry, frosty storage climate at -18 °C. A frosty climate is great for storing frozen food and frozen goods for several months, making ice cubes and freezing fresh food.

Freezing food

You can freeze as many kilograms of fresh food within 24 hours as indicated on the nameplate (see 9.5 Model plate) under "freezing capacity ... kg/24h".

So that the food is rapidly frozen through to the core, keep to the following quantities per pack:

- Fruit, vegetables up to 1 kg
- Meat up to 2.5 kg

Before freezing goods, please make sure of the following:

- Appliances without NoFrost:*
SuperFrost is activated (see 6.3 Functions) when the amount of food to freeze exceeds approx. 1 kg.
*
- Appliances with NoFrost:*
SuperFrost is activated (see 6.3 Functions) when the amount of food to freeze exceeds approx. 2 kg.
*
- With a small amount of frozen goods: SuperFrost is activated approx. 6 hours prior.
- With the maximum amount of frozen goods: SuperFrost is activated approx. 24 hours prior.

Arrange your food as follows:



CAUTION

Risk of injury from glass fragments!
Drink bottles and cans may explode if frozen. This applies particularly to carbonated drinks.

- ▶ Do not freeze bottles and cans of drink!

- With a small amount of frozen goods:
 - ▶ Distribute packaged groceries across all drawers.
 - ▶ If possible, place groceries at the back of the drawer near the rear wall.
- With a maximum amount of frozen goods:
 - ▶ Distribute packaged groceries across all drawers.
 - ▶ If possible, place groceries at the back of the drawer near the rear wall.
- With a maximum amount of frozen goods:
 - ▶ Once SuperFrost deactivates automatically, place food into the drawer.

Defrost the food

- In the fridge
- In the microwave
- In the stove/oven
- At room temperature



WARNING

Risk of food poisoning!
▶ Do not re-freeze thawed food.

- ▶ Only take out the food you need at the time.
- ▶ Cook defrosted food as soon as possible.

4.2 Storage times

Refer to the specified storage times as a guide.
In the case of foods with a minimum shelf life, the date indicated on the packaging still applies.

4.2.1 Fridge section

Always follow the best-before date stated on the packaging.

4.2.2 Freezer compartment

Recommended storage period for various types of food		
Ice cream	at -18 °C	2 to 6 months
Sausages, ham	at -18 °C	2 to 3 months
Bread, baked goods	at -18 °C	2 to 6 months
Game, pork	at -18 °C	6 to 9 months
Fatty fish	at -18 °C	2 to 6 months
Lean fish	at -18 °C	6 to 8 months
Cheese	at -18 °C	2 to 6 months
Poultry, beef	at -18 °C	6 to 12 months
Vegetables, fruit	at -18 °C	6 to 12 months

5 Saving energy

- Pay attention to good ventilation. Do not cover ventilation holes or grids.
- Always keep the fan air slits clear.
- Do not install the appliance in direct sunlight, next to an oven, radiator or similar.
- Energy consumption depends on the installation conditions, e.g. the ambient temperature (see 1.4 Appliance range of use) . A warmer ambient temperature can increase the energy consumption.
- Open the appliance for as short a time as possible.
- The lower the temperature is set the higher the energy consumption.
- Sort your food: home.liebherr.com/food.
- Keep all food properly packed and covered. This prevents frost from forming.
- Only take food out for as long as necessary so that it doesn't warm up too much.
- Inserting warm food: allow to cool down to room temperature first.
- Thaw frozen food in the refrigerator.
- If there is a thick layer of frost in the appliance: defrost the appliance.*
- For longer periods of absence, use HolidayMode (see HolidayMode) .

6 Controls

6.1 Controls and displays

The display provides a quick overview of the temperature setting and the status of functions and settings. You can control the functions and settings either by deactivating/activating them or by selecting a value.

6.1.1 Status display

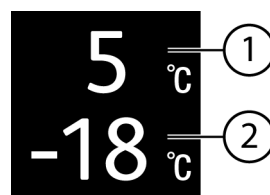

Controls

Fig. 4

- (1) Temperature display of the fridge section (2) Freezer compartment temperature display

The Status display shows the set temperature and is the home display. From there, you can navigate to the options and settings.

6.1.2 Navigation

Navigate in the menu to access the individual functions. An audible signal sounds after confirming a function or setting. If no selection is made after 10 seconds the display switches to the Status display.

The appliance is operated with the buttons next to the display.



Fig. 5

- (1) Navigation arrow left/right (2) Confirm

Navigation arrow left/right Fig. 5 (1):

- Navigating in the menu. After the last menu page, it goes back to the first one.

Confirm Fig. 5 (2):

- Activating/deactivating a function.
- Open a submenu.
- Confirm a selection. After confirmation the display switches back to the menu.

Back to Status display: in the fastest manner:

- Close and open the door.
- or wait 10 seconds. The display switches to the Status display.

6.1.3 Operating structure

The controls are explained by a template. The display changes depending on the function or settings.

Menus without a submenu

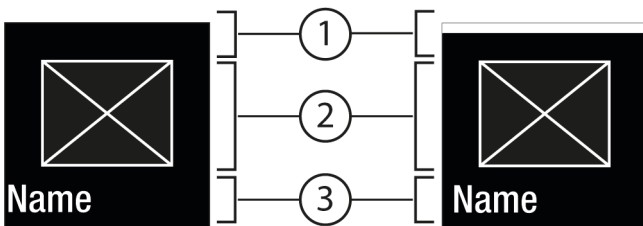

Fig. 6

- (1) Status deactivated / status activated white bar in the top area (3) Menu: Function name or menu: Setting name
- (2) Symbol or activated value

Menus with a submenu

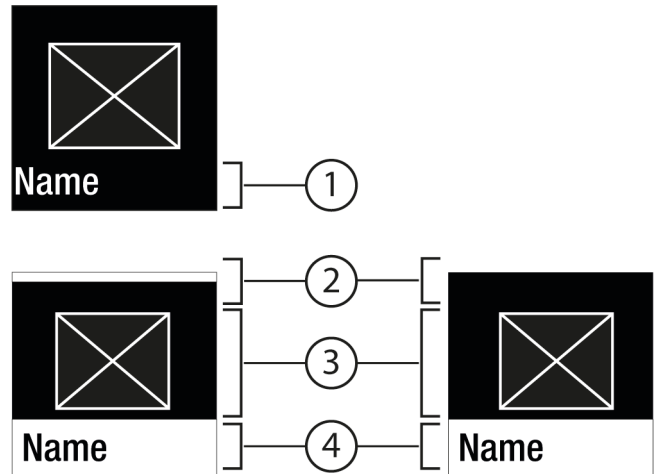

Fig. 7

- (1) Menu: Function name or menu: Setting name (3) Symbol or activated value
- (2) Status (4) Submenu: function name or submenu: Setting name

- (2) off / on

You can navigation as follows:

- Press the left/right Fig. 5 (1) arrow to navigate.
- Press Confirm Fig. 5 (2) to open the submenu Fig. 7 (4).
 - Press the left/right Fig. 5 (1) arrow to navigate.
 - Set a new value: Press Confirm Fig. 5 (2) to select an active value Fig. 6 (1).
 - Back to the menu: Press Confirm Fig. 5 (2) to select the active value Fig. 6 (2).

6.1.4 Display symbols

Display symbols provide information on the current appliance status:

Symbol	Appliance status
	Standby The appliance or temperature zone is switched off.
	Flashing number Appliance is working. Temperature flashes until the set value is reached.
	Flashing symbol Appliance is working. Setting is made.
	Bar grows steadily Function is activated.

6.2 Control concept

6.2.1 Activating/deactivating the function

You can activate/deactivate the following functions:

Symbol	Function
	SuperCool ^{IX}

Symbol	Function
	PowerCool ^x
	SuperFrost ^x
	IceMaker and MaxIce ^{x*}
	PartyMode ^x
	HolidayMode
	E-Saver

- ^x When function is on, the appliance works harder. This means appliance noise when operating may be louder for a short while, and more energy will be consumed.
- ▶ Press the navigation arrows *Fig. 5 (1)* repeatedly until the function is displayed.
 - ▶ Press Confirm *Fig. 5 (2)*.
 - ▷ You hear the confirmation tone.
 - ▷ Status appears in the menu.
 - ▷ Function is on/off.

6.2.2 Selecting function value

With the following functions you can set a value in the submenu:

Symbol	Function
	Cool: Setting the temperature Turn on/off the temperature zone
	Freeze: Setting the temperature Switch the appliance on/off

- ▶ Tap the navigation arrows *Fig. 5 (1)* repeatedly until the function is displayed.
- ▶ Press Confirm *Fig. 5 (2)*.
- ▶ Select the setting value with the navigation arrows *Fig. 5 (1)*.

Setting the temperature

- ▶ Press Confirm *Fig. 5 (2)*.
- ▷ You hear the confirmation tone.
- ▷ Status: On *Fig. 6 (1)* appears briefly in the submenu *Fig. 7 (4)*.
- ▷ Display switches back to the menu.

Switching the temperature zone on/off

- ▶ To Confirm, press for 3 seconds.
- ▷ You hear the confirmation tone.
- ▷ Display returns to the Status screen.

6.2.3 Activating/deactivating settings

You can activate/deactivate the following settings:

Symbol	Setting
	WiFi ¹

Symbol	Setting
	Entry lock ²
	SabbathMode ²
	Cleaning Mode ^{2*}
	Reminders ¹
	Reset ²
	Switch off ²

- ▶ Tap the navigation arrows *Fig. 5 (1)* repeatedly until the settings appear.
- ▶ Press Confirm *Fig. 5 (2)*.
- ▶ Tap the navigation arrows *Fig. 5 (1)* repeatedly until the desired setting is displayed.

¹ Activate setting (shortpress)

- ▶ Press Confirm *Fig. 5 (2)*.
- ▷ You hear the confirmation tone.
- ▷ Status appears in the menu.
- ▷ Setting is on / off.

² Activate setting (longpress)

- ▶ To Confirm *Fig. 5 (2)*, press for 3 seconds.
- ▷ You hear the confirmation tone.
- ▷ Status appears in the menu.
- ▷ Display changes.

6.2.4 Selecting the setting value

With the following settings you can set a value in the submenu:

Symbol	Settings
	Brightness
	Door alarm

- ▶ Tap the navigation arrows *Fig. 5 (1)* repeatedly until settings appears.
- ▶ Press Confirm *Fig. 5 (2)*.
- ▶ Tap the navigation arrows *Fig. 5 (1)* repeatedly until the desired setting is displayed.
- ▶ Press Confirm *Fig. 5 (2)*.
- ▶ Select the setting value with the navigation arrows *Fig. 5 (1)*.
- ▶ Press Confirm *Fig. 5 (2)*.
- ▷ You hear the confirmation tone.
- ▷ Status appears briefly in the submenu.
- ▷ Display switches back to the menu.

6.2.5 Go to the Customer menu

You can see the following settings in the Customer menu:

Symbol	Function
	D-Value ^{1*}

Controls

Symbol	Function
	Defrost ^{2*}
	TubeClean ^{2*}
	Ice cubes ^{1*}
	Software

- ▶ Press the navigation arrows *Fig. 5 (1)* repeatedly until the settings appear.
- ▶ Press Confirm *Fig. 5 (2)*.
- ▶ Press the navigation arrows *Fig. 5 (1)* repeatedly until the appliance information appears in the display.
- ▶ Press Confirm *Fig. 5 (2)*.
- ▶ Enter the numerical code 151.
- ▷ The customer menu appears.
- ▶ Press the navigation arrows *Fig. 5 (1)* repeatedly in the customer menu until the desired setting appears.

¹ Select the value

- ▶ Press Confirm *Fig. 5 (2)*.
- ▷ You hear the confirmation tone.
- ▷ Status appears briefly in the display.
- ▷ Display switches back to the menu.

² Activate the setting

- ▶ To Confirm *Fig. 5 (2)*, press for 3 seconds.
- ▷ You hear the confirmation tone.
- ▷ Status appears on the display.
- ▷ The symbol flashes as long as the appliance is working.

6.3 Functions



Turn off appliance

This setting turns off the whole appliance.

Switching off the entire appliance

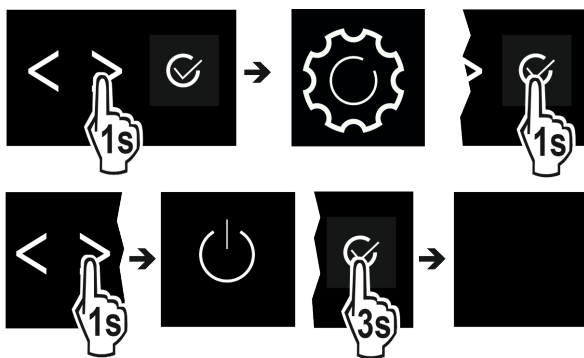

Fig. 8

- ▶ Turning off the IceMaker.*
- ▶ Activating/deactivating (see 6.2 Control concept).
- ▷ Off: Display goes black.



WiFi

Use this function to connect your appliance to the WiFi. You can then operate it via the SmartDevice app on a mobile device. You can also use this function to disconnect or reset the WiFi connection. To connect your appliance to the WiFi, you need the SmartDeviceBox. For more information about the SmartDeviceBox and how to use the SmartDevice app: (see 1.3 SmartDevice)

Note

You cannot use the SmartDeviceBox in the following countries: Belarus, Kazakhstan, Russia. The SmartDevice function is not available.

Establishing a WiFi connection

Make sure that the following requirements are fulfilled:

- You have purchased and inserted a SmartDeviceBox. (see 1.3 SmartDevice)
- You have installed the SmartDevice app (see apps.home.liebherr.com).

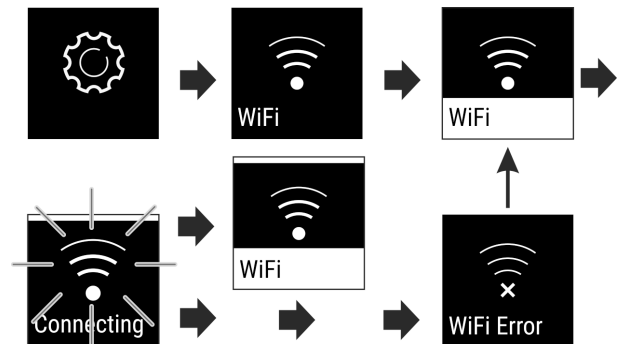

Fig. 9

- ▶ Activate the setting. (see 6.2 Control concept)
- ▷ Connection is established: Status: activated *Fig. 6 (1)* and WiFi connecting appears. The symbol flashes.
- ▷ Connection is established: Status: activated *Fig. 6 (1)* appears.
- ▷ Connection failed: Status and Connect appear. The symbol is permanently visible.

Disconnecting from the WiFi

- ▶ Deactivate the setting. (see 6.2 Control concept)

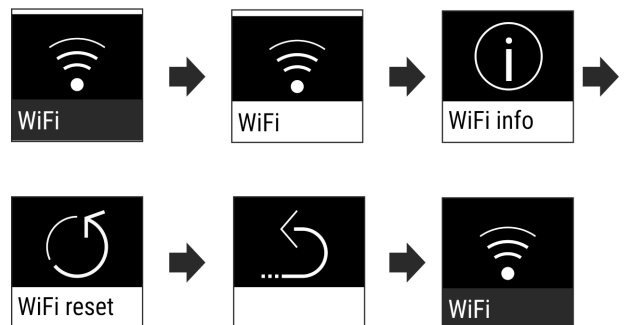

Fig. 10

- ▷ There is no connection: Symbol is permanently visible.

Resetting the WiFi connection

- ▶ Reset settings. (see 6.2 Control concept)

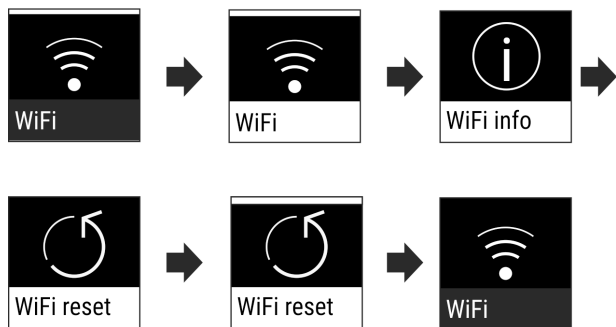

Fig. 11

- ▷ The connection and other settings are reset to the factory settings.

5 °C Temperature

The temperature depends on the following factors:

- The amount of times the door is opened
- How long the door is open for
- The room temperature of the installation site
- The type, temperature and amount of food

Temperature zone	Recommended setting
5 °C Fridge section	5 °C
-18 °C Freezer compartment	-18 °C

Setting the temperature

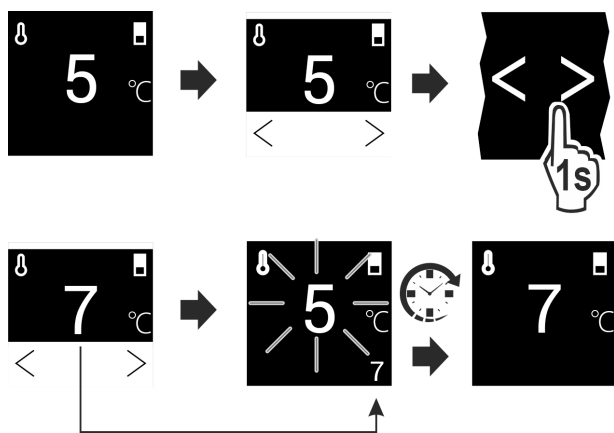

Fig. 12

- ▶ Set the value. (see 6.2 Control concept) .
- ▷ Set temperature is shown at the bottom right of the display.

Switching off a temperature zone

You can switch off the fridge compartment separately. If you switch off the freezer compartment, all temperature zones are switched off.

- ▶ Deactivate IceMaker. *
- ▶ Set the value. (see 6.2 Control concept) .

- ▷ appears.

D1 D-Value*

Note

Liebherr recommends:*

- ▶ Operate the appliance with dry rear panel to avoid visible condensation and goods freezing to the rear panel or each other.*

The *D-Value* specifies whether you are operating your fridge compartment with or without a dry rear panel. The rear panel is mounted in the appliance in its delivery condition. The default setting for the *D-Value* is *D1*.*

You can remove the rear panel for cleaning. (see 8.4.3 Cleaning the dry rear panel*) To operate the appliance without a rear panel, you need to set the *D-Value* to *D2*.*

Choose the setting*

- ▶ Set the value in the customer menu. (see 6.2 Control concept)

* SuperCool

This function selects the lowest cooling temperature. This gives you colder storage temperatures.

This function is relevant to the fridge section Fig. 1 (A)

Use:

- Cool large amounts of food quickly.

Activating/deactivating the function

- ▶ Using the fridge section: activate the function when you add the goods.
- ▶ Activating/deactivating (see 6.2 Control concept) .

The function automatically turns off. The appliance goes back to normal mode. The temperature adjusts itself to the set level.

* PowerCool

This function provides the perfect blanket temperature to cool your food.

This function refers to the fridge section Fig. 1 (A).

Use:

- At higher room temperatures (from approx. 35 °C)
- When humidity is high e.g. on summer days
- When storing moist goods, to avoid condensation building up inside

Activating/deactivating the function

- ▶ Activating/deactivating (see 6.2 Control concept) .

Note

The fan can run even when function is deactivated. This ensures optimal temperature distribution in the appliance.

- ▷ Function activated: Energy consumption of the appliance is slightly increased.

* SuperFrost

This function selects the lowest freezing temperature. This gives you colder storage temperatures.

This function refers to the freezer section Fig. 1 (C).

Controls

Use:

- For storing more than 2 kg fresh food every day.
- Freezing fresh food quickly to the core.
- Increasing the cold reserves in the stored goods before defrosting the appliance.

Activating/deactivating the function

With a small amount to freeze:

- ▶ Activate 6 hours before use.
- ▶ Activate 24 hours before use.
- ▶ Activating/deactivating (see 6.2 Control concept) .

The function automatically turns off. The appliance goes back to normal mode. The temperature adjusts itself to the set level.



PartyMode

This option offers an assortment of special functions and settings that are useful if you are having a party.

The following functions are on:

- *SuperCool*
- *SuperFrost*
- *IceMaker* and *MaxIce**

All the functions can be adjusted flexibly and separately. Changes are discarded when the function turns off.

Activating/deactivating the function

- ▶ Activating/deactivating (see 6.2 Control concept) .
- ▷ On: All functions are activated at the same time.
- ▷ Deactivated: Previously set temperatures are restored.

After 24 hours the function turns off automatically.



HolidayMode

This function minimises the energy consumption during an extended absence. The temperature of the refrigerator compartment is set to 15 °C and this is displayed on the status screen when the temperature has been reached.

The set freezer temperature remains unchanged.

This function refers to the fridge section *Fig. 1 (A)*.

Use:

- Save energy if you plan to be away for a while.
- Avoid coming home to bad smells and mould.

Activating/deactivating the function

- ▶ Empty everything from the fridge section.
- ▶ Activating/deactivating (see 6.2 Control concept) .
- ▷ On: Fridge temperature is raised.
- ▷ Off: the previously set temperature is restored.



SabbathMode

With this function you can activate or deactivate the SabbathMode. If you activate this function, some electronic functions will be switched off. This allows your appliance to meet religious requirements on Jewish holidays such as the Sabbath and comply with STAR-K Kosher certification.

Appliance status with active SabbathMode
The status display continuously shows SabbathMode.
All functions in the display except the Deactivate SabbathMode function are locked.
Active functions remain active.

Appliance status with active SabbathMode
The display stays lit when you close the door.
The interior lighting is off.
Reminders are disabled. The set time intervals are paused.
Reminders and warnings are not displayed.
There is no door alarm.
There is no temperature alarm.
The IceMaker is out of operation.*
The defrost cycle only works for the specified time without taking account of appliance use.
After a power failure, the appliance returns to SabbathMode.

Appliance status

Note

This appliance has certification from the "Institute for Science and Halacha". (www.machonhalacha.co.il)

You can find a list of STAR-K-certified appliances at www.star-k.org/appliances.

Activating SabbathMode



WARNING

Danger of food poisoning from spoiled food!

If you have SabbathMode activated and a power failure occurs, no message appears in the status display about the power failure. Once the power is restored, the appliance continues to operate in SabbathMode. The power failure may mean that food spoils and the consumption of this food could lead to food poisoning.

After a power failure:

- ▶ Do not consume food that was frozen and has thawed out.

- ▶ Call up the settings menu. (see 6.2 Control concept)
- ▶ Tap the navigation arrow repeatedly until the corresponding function is displayed.

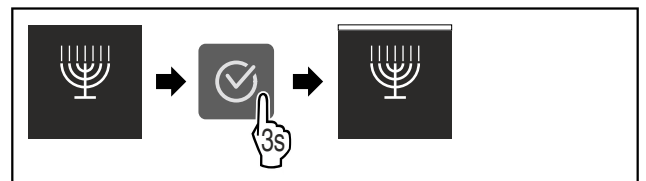

Fig. 13

- ▶ Complete the steps (see Fig. 440) .
- ▷ SabbathMode is activated.
- ▷ Status display continuously shows SabbathMode.

Deactivating SabbathMode

- ▶ Call up the settings menu. (see 6.2 Control concept)
- ▶ Tap the navigation arrow repeatedly until the corresponding function is displayed.

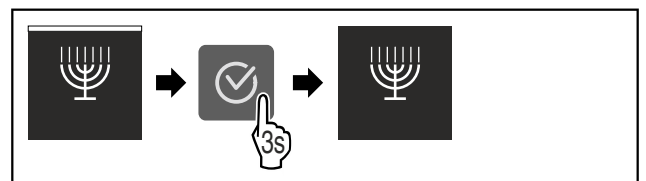

Fig. 14

- ▶ Complete the steps (see Fig. 441) .
- ▷ SabbathMode is deactivated.

E-Saver

This function activates or deactivates the energy-saving mode. When you activate this function, the energy consumption decreases and the temperature increases by 2 °C in the appliance. The food remains fresh, but the shelf life is shortened.

Temperature zone	Recommended setting (see Temperature)	Temperature when E-Saver activated
5 °C Fridge compartment	5 °C	7 °C
-18 °C Freezer compartment	-18 °C	-16 °C

Temperatures

Activating E-Saver

- ▶ Tap navigation arrow repeatedly until corresponding function is displayed.

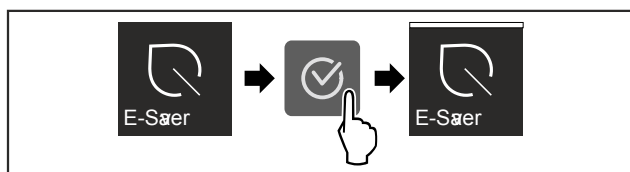

Fig. 15

- ▶ Complete the steps (see Fig. 442).
- ▷ Energy-saving mode is activated.

Deactivating E-Saver

- ▶ Tap navigation arrow repeatedly until corresponding function is displayed.

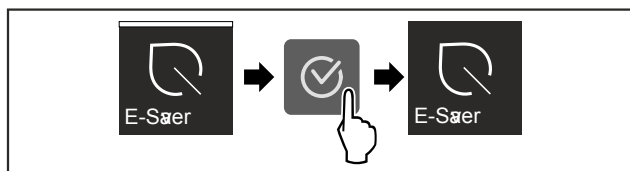

Fig. 16

- ▶ Complete the steps (see Fig. 443).
- ▷ Energy-saving mode is deactivated.

IceMaker*

You can activate or deactivate ice cube production with this function.

More information on the number of ice cubes:	(see 9.1 Technical specifications)
More information on increasing the number of ice cubes:	(see MaxIce*)
More information on the size of the ice cubes:	
More information on cleaning the lines of the IceMaker:	(see TubeClean*)

Activating IceMaker

Make sure that the following requirements are fulfilled:

- IceMaker is put into operation. (see 7.10 IceMaker*)
- Water tank is filled. (see 7.10.1 Fill the water tank)

- ▶ Tap navigation arrow repeatedly until corresponding function is displayed.

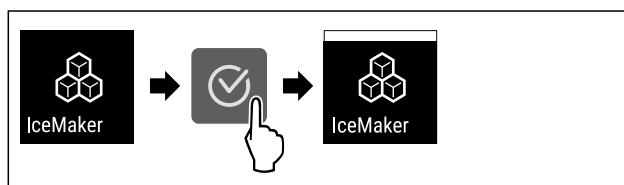

Fig. 17

- ▶ Complete the steps (see Fig. 444).
- ▷ IceMaker is activated. It can take up to 24 hours for the IceMaker to produce the first ice cubes.

Deactivating IceMaker

Make sure that the following requirements are fulfilled:

- Water tank is empty. (see 7.10 IceMaker*)
- ▶ Tap navigation arrow repeatedly until corresponding function is displayed.



Fig. 18

- ▶ Complete the steps (see Fig. 445).
- ▷ IceMaker is deactivated.
- ▷ If ice cubes are currently being made, the system completes the process.
- ▷ The IceMaker goes off automatically.

Ice cubes*

Set the ice cube size.*

Choose the setting*

- ▶ Set the size in the Customer menu (see 6.2 Control concept).

MaxIce*

Use this function to increase the number of ice cubes in the IceMaker.

More information on the number of ice cubes:	(see 9.1 Technical specifications)
--	------------------------------------

Activating MaxIce

If you activate MaxIce and have not previously activated the IceMaker (see IceMaker*) function, then by pressing MaxIce you can also automatically activate the IceMaker function.

If you have not yet activated the IceMaker function, make sure that the following requirements are met:

- IceMaker is put into operation. (see 7.10 IceMaker*)
- Water tank is filled. (see 7.10.1 Fill the water tank)
- ▶ Tap navigation arrow repeatedly until corresponding function is displayed.

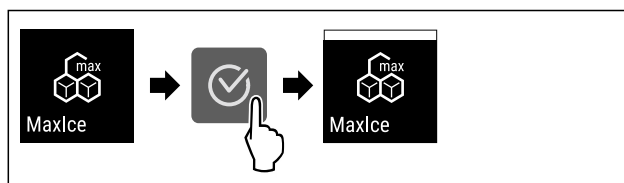

Controls

Fig. 19

- ▶ Complete the steps (see Fig. 446) .
- ▷ MaxIce is activated.
- ▷ If you have not activated the IceMaker function before: IceMaker is activated.

Deactivating MaxIce

If you deactivate MaxIce, then the IceMaker function is still activated.

- ▶ Tap navigation arrow repeatedly until corresponding function is displayed.

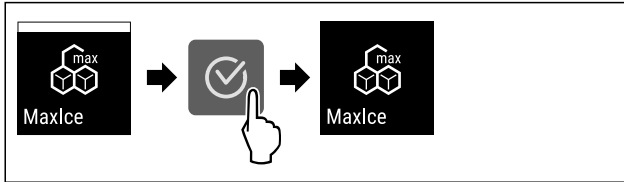

Fig. 20

- ▶ Complete the steps (see Fig. 447) .
- ▷ MaxIce is deactivated.



TubeClean*

This setting cleans the IceMaker pipes.*

Ensure that the following conditions are met:*

- IceMaker cleaning is ready (see 8.4.5 Cleaning the IceMaker*).

Activating the setting*

- ▶ Activate the setting in the Customer menu (see 6.2 Control concept) .
- ▷ The rinse process is ready (max. 60 min.): Symbol flashes.
- ▷ Water pipes are rinsed: Symbol flashes.
- ▷ Rinsing process is complete: Function turns off automatically.



CleaningMode*

Use this setting to easily clean the appliance.*

This setting refers to the fridge section Fig. 1 (A)*.

Use:*

- Clean the fridge section by hand.

What happens on the appliance when this setting is on:*

- The fridge section is switched off.
- The internal light is on.
- Reminders and warnings are not shown. There is no acoustic signal.

Activating/deactivating settings*

- ▶ Activating/deactivating the setting (see 6.2 Control concept) .
- ▷ On: fridge section is off. Light stays on.
- ▷ Off: preset temperature is restored.

After 60 min the setting turns off automatically. The appliance then continues running in normal mode.



Display brightness

Set the brightness level of the display.

You can set the following brightness levels:

- 40%
- 60%

- 80%
- 100%

Choose the setting

- ▶ Set the level (see 6.2 Control concept) .



Door alarm

Set the time before the door alarm (see Close the door) sounds.

The options are as follows:

- 1 min
- 2 min
- 3 min
- Off

Choose the setting

- ▶ Set the time (see 6.4 Fault messages) .



Entry lock

This setting prevents unintentional use of the appliance, e.g. by children.

Use:

- Avoid settings being changed unintentionally.
- Avoid the appliance being switched off unintentionally.
- Avoid the temperature being changed unintentionally.

Activating/deactivating settings

- ▶ Activating/deactivating. (see 6.2 Control concept)



Info

This setting allows the appliance information to be read out as well as access to the customer menu.

It provides the following information:

- Model name
- Index
- Serial number
- Service number

Show appliance data

- ▶ Tap the navigation arrows Fig. 5 (1) repeatedly until the  settings appear.
- ▶ Press Confirm Fig. 5 (2).
- ▶ Tap the navigation arrows Fig. 5 (1) repeatedly until the information is displayed.
- ▶ Read the appliance info.



Reminder

Reminders are given out acoustically by a beep and visually by a symbol in the display. The signal gets louder until the alert stops.



Replace FreshAir active carbon filter

This message appears when the air filter needs replacing.

- ▶ Change the air filter every six months.
- ▶ Confirm the message with OK.
- ▷ The service interval resets.
- ▷ The air filter guarantees the air quality in the fridge.

Activating the setting

- ▶ Activating/deactivating (see 6.2 Control concept) .



Reset

This function resets all settings to the factory settings. All settings that you have made thus far will be reset to their original values.

Activating the setting

- ▶ Activate (see 6.2 Control concept) .

6.4 Fault messages

Fault messages appear in the display. There are two categories of fault message:

Category	Meaning
Message	Reminder of general procedures. You can carry out these procedures to eliminate the message.
Warning	Appears when there are malfunctions. A signal sounds in addition to the display. The signal becomes louder until you acknowledge by tapping the display. You can eliminate simple defects yourself. For more serious defects, you must contact customer service.

6.4.1 Warnings



Close the door

This message appears if the door is open for too long.

You can set how long it takes for this message to appear .

- ▶ Stop alarm: Confirm the message.

-or-

- ▶ Close the door.



Power cut

This message appears if the freezer temperature increased due to a power cut. After the power is restored, the appliance continues to work at the set temperature.

- ▶ Stop alarm: Confirm the message.
- ▷ Temperature alert appears (see Temperature alarm) .



Temperature alarm

This message appears if the freezer temperature does not match the set temperature.

Variations in temperature could be because:

- Hot, fresh food was inserted.
- Too much warm room air flowed in when rearranging and removing food.
- The power was cut off for a while.
- The appliance is faulty.

When the fault is eliminated the appliance continues to work at the set temperature.

- ▶ Confirm the display.
- ▷ The highest temperature is shown.
- ▶ Confirm display again.
- ▷ The status display is displayed.
- ▷ The current temperature is shown.



Error

This message appears if there is a fault with the appliance. An appliance component indicates a fault.

- ▶ Open the door.
- ▶ Note down the fault code.
- ▶ Confirm the message.
- ▷ The signal tone stops.
- ▷ The status display appears.
- ▶ Close the door.
- ▶ Contact customer service. (see 9.4 Customer Services)

6.4.2 Message



Water tank

This message appears if there is not enough water in the water tank.

- ▶ Fill the water tank.
- ▷ The IceMaker produces ice cubes.
- ▶ When the water tank is full and the following message appears: Check if the float is stuck.
- ▶ If necessary, drain the water and release the float with a thin object such as a cotton bud.
- ▶ When the water tank is full and the following message appears: Contact customer service. (see 9.4 Customer Services)



Insert IceMaker drawer*

This message appears if the IceMaker drawer is open.

- ▶ Push in the IceMaker drawer.
- ▷ The message disappears.
- ▷ The IceMaker produces ice cubes.

6.4.3 DemoMode

If “D” appears on the display, demo mode is on. This option is designed for retailers, as it turns off all the cooling functions.

Stopping DemoMode

If you see the following running in the display:

- ▶ Confirm the display within the countdown.
- ▷ DemoMode is off.
- If the timer is not running:
- ▶ Unplug the appliance.
- ▶ Plug the appliance in again.
- ▷ DemoMode is off.

7 Features

7.1 Door rack

7.1.1 Move/remove the door rack

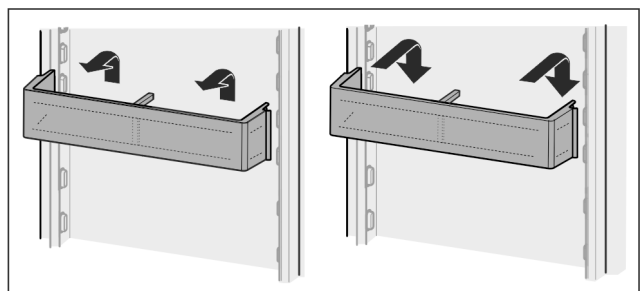

Fig. 21

- ▶ Slide the rack upwards.
- ▶ Pull forwards.

Features

- ▶ Re-insert it in reverse order.

7.1.2 Disassembling the door rack

The door rack can be taken apart for cleaning.

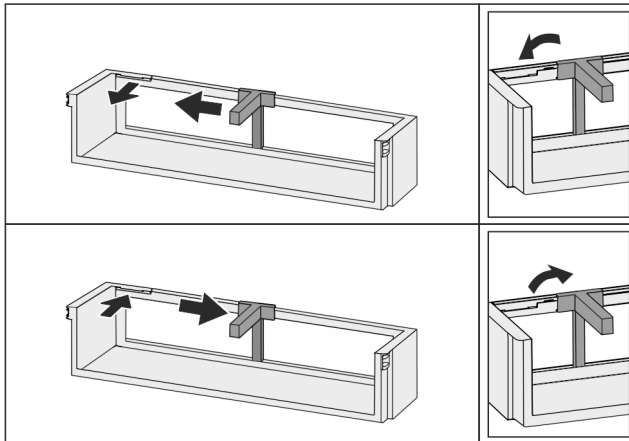

Fig. 22

- ▶ Disassemble the door rack.

7.2 Shelves

7.2.1 Adjusting/removing the shelves

The shelves are prevented from being pulled out accidentally by pull out stops.

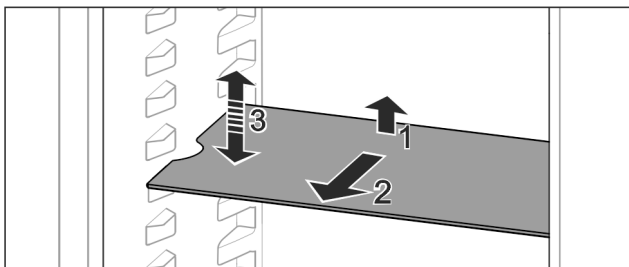

Fig. 23

- ▶ Lift the shelf and pull forward.
- ▷ Line up the side runner.
- ▶ Adjust the height of the shelf: Lift or lower it to the desired height and slide it in.

-or-

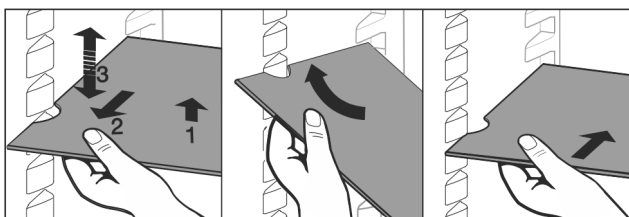

Fig. 24

- ▶ Remove the shelf completely: Pull it out to the front.
- ▶ Easier removal: Set the shelf at an angle.
- ▶ Insert the shelf again: Slide it in all the way.
- ▷ The pull-out stoppers point downwards.
- ▷ The pull-out stoppers are behind the front support.

You can also remove the shelf above the EasyFresh compartments.

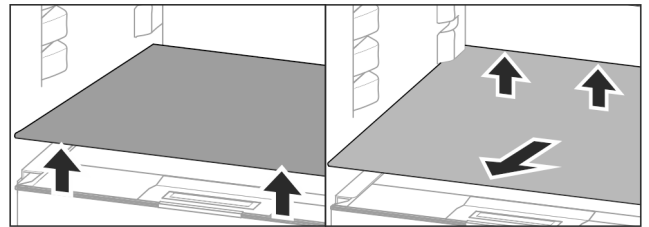

Fig. 25

Removing the shelf:

If the IceMaker (see 7.10 IceMaker*) has been removed:

- ▶ Lift the shelf at the front and back.
- ▶ Pull it out towards you.

Do not store any goods on the compartment cover below!

Inserting the shelf:

- ▶ Place the shelf at an angle, sloping down towards the back.
- ▷ The pull-out stoppers point downwards.
- ▶ Slide the shelf into place.

7.2.2 Dismantling the shelves

The shelves can be dismantled for cleaning.

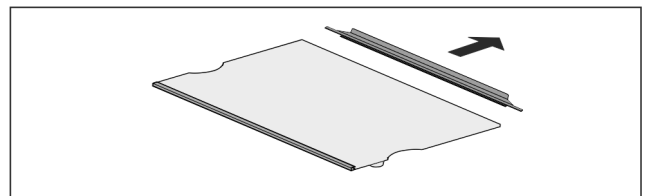

Fig. 26

- ▶ Dismantling the shelf.

7.3 Dividing shelf*

7.3.1 Using the dividing shelf

The shelves are prevented from being pulled out accidentally by pull out stops.

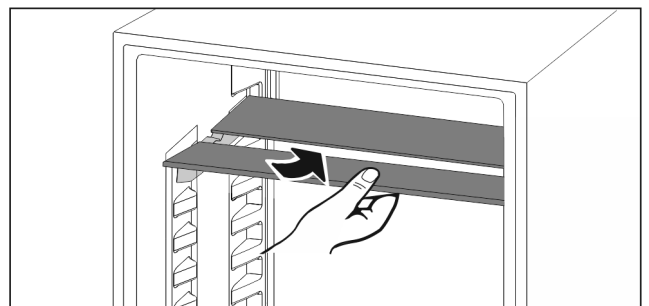

Fig. 27

- ▶ Push the dividing shelf underneath as shown.

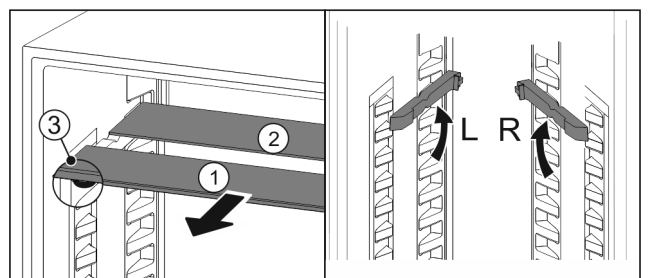

Fig. 28

Adjusting the height:

- ▶ Pull the glass panels out Fig. 28 (1) from the front, one at a time.

- ▶ Release the support rails and click in at the height you want.
- ▶ Slide in the glass panels one at a time.
- ▷ Flat pull-out stoppers at the front, right behind the support rails.
- ▷ High pull-out stoppers at the back.

Using both shelves:

- ▶ Hold the glass panel with one hand and pull it to the front.
- ▷ The glass panel *Fig. 28 (1)* and trim strip are at the front.
- ▷ The stops *Fig. 28 (3)* point down.

7.4 VarioSafe*

The VarioSafe provides space for compact foodstuffs and packages, pots and glasses.

7.4.1 Using the VarioSafe

You can remove the drawer and slide it back in at 2 different heights. This is handy for storing taller items in the drawer.

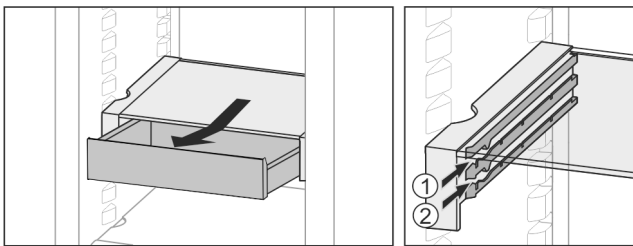

Fig. 29

- ▶ Remove the drawer.
- ▶ Slide back at the height you want *Fig. 29 (1)* or *Fig. 29 (2)*.

7.4.2 Repositioning the VarioSafe

You can shift the height of the entire VarioSafe.

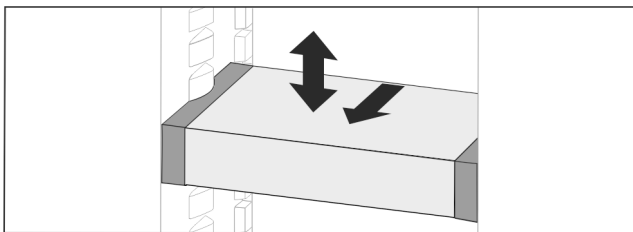

Fig. 30

- ▶ Pull forwards.
- ▷ Line up the side runner.
- ▶ Lift or lower to the height you want.
- ▶ Slide to the rear.

7.4.3 Removing the entire VarioSafe

You can remove VarioSafe as a whole unit.

- ▶ Pull forwards.
- ▷ Line up the side runner.

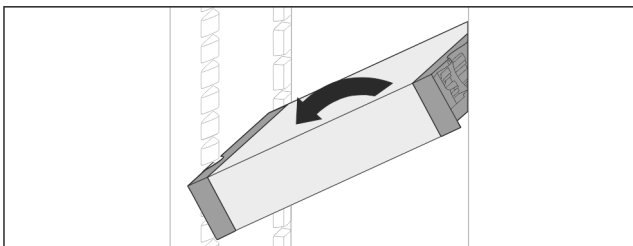

Fig. 31

- ▶ Tip to the side and pull towards you.

7.4.4 Disassembling the VarioSafe

You can take the VarioSafe apart for cleaning.

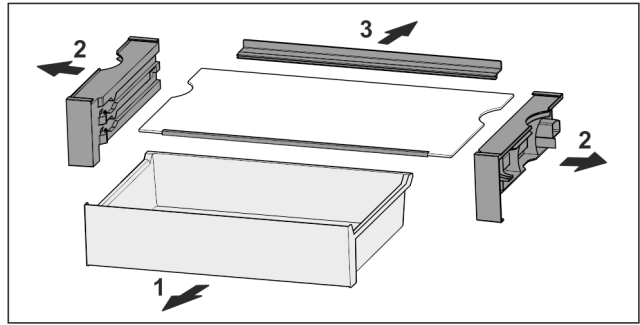

Fig. 32

- ▶ Disassembling the VarioSafe

7.5 Space for baking tray

There is space for a baking tray *Fig. 1 (8)* above the drawers.



Fig. 33

Ensure that the following conditions are met:

- Max. baking tray dimensions are adhered to (see 9.1 Technical specifications).
- Baking tray is cooled to room temperature.
- The lowest door rack is set at least one position higher.

With the door open to 90°:

- ▶ Slide the baking tray onto the lower side runners.

7.6 Drawers

You can remove the drawers for cleaning.

You can remove the drawers to use VarioSpace.

The way to remove/insert the drawers varies depending on the pull-out system. Your appliance can contain various pull-out systems.

For appliances with NoFrost*:

Note

The energy consumption increases and the cooling power goes down if ventilation is not sufficient.*

- ▶ Leave the bottom drawer in the appliance!*
- ▶ Always leave the fan air vents clear on the back wall!*

For appliances without NoFrost*:

Note

The energy consumption increases and the cooling power goes down if ventilation is not sufficient.*

- ▶ Always leave the fan air vents clear on the back wall!*

7.6.1 Drawer on appliance base or glass shelf

The drawer runs directly on the appliance base or on a glass shelf. There are no rails.

When you remove the drawers, you can use the glass shelves below them as storage shelves.

Features

Removing drawer

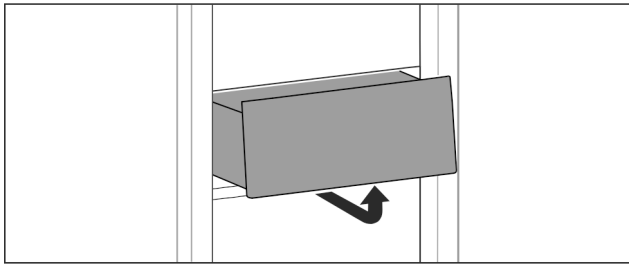

Fig. 34

- ▶ Remove drawer as shown in the illustration.

Inserting drawer

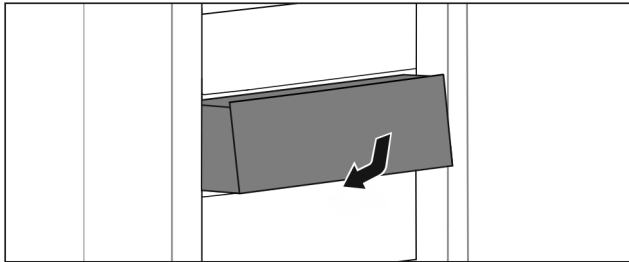

Fig. 35

- ▶ Insert drawer as shown in the illustration.

7.6.2 Drawer on rails

Removing drawer

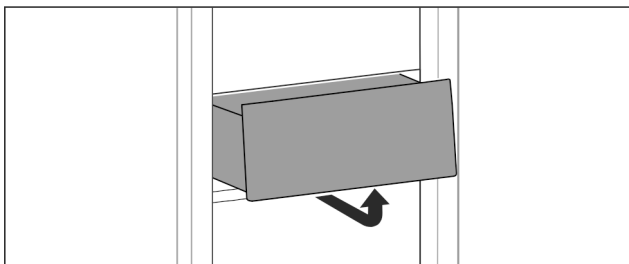

Fig. 36

- ▶ Remove drawer as shown in the illustration.

Inserting drawer

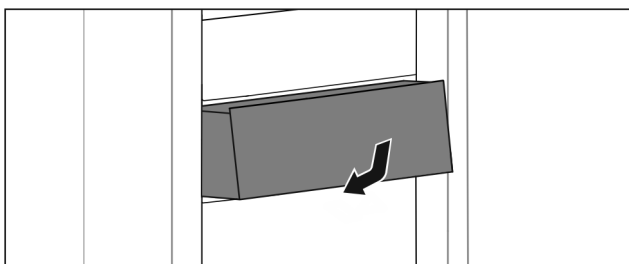

Fig. 37

- ▶ Insert drawer as shown in the illustration.

7.6.3 Drawer on telescopic rails

The drawer runs on extendible rails (telescopic rails). There are fully extendible telescopic rails and telescopic rails with partial pull-out. Drawers which are fully extendible can be pulled out fully from the appliance. Drawers with partial pull-out cannot be removed fully from the appliance. The system in your appliance depends on the type of appliance.

Fully extendible*

If you have fully extendible rails, there is a clamp located at the back on the left and right of the rail.

Removing drawer

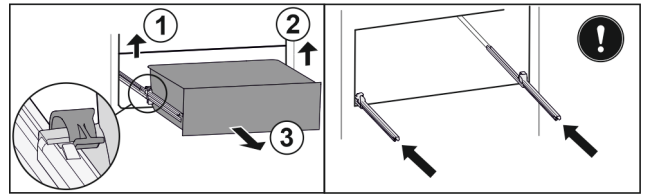

Fig. 38

- ▶ Pull out drawer as far as it will go.
- ▶ Lift left clamp and simultaneously pull drawer forwards on the left. Fig. 38 (1)
- ▶ Lift right clamp and simultaneously pull drawer forwards on the right. Fig. 38 (2)
- ▶ Remove drawer to the front. Fig. 38 (3)
- ▶ Slide rails in.

Inserting drawer

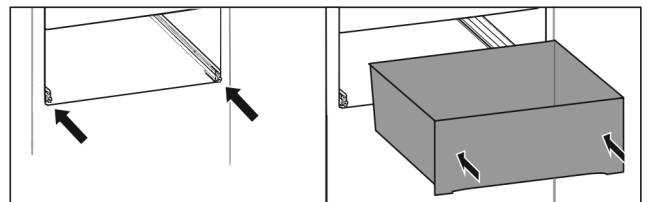

Fig. 39

- ▶ Slide rails in.
- ▶ Place drawer on rails.
- ▶ Slide in drawer to the back.
- ▷ Drawer latches in audibly at the back.

Partial pull-out fridge compartment*

Removing drawer

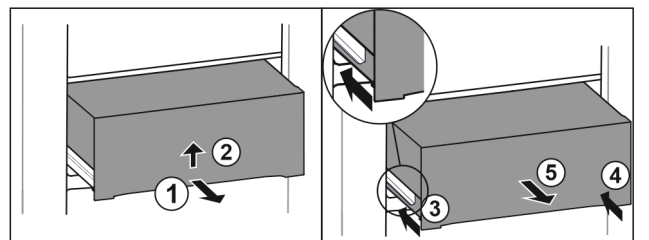

Fig. 40

- ▶ Pull out drawer half-way. Fig. 40 (1)
- ▶ Lift the drawer from the bottom. Fig. 40 (2)
- ▶ Lift and hold the drawer and at the same time pull it forwards.
- ▶ Insert left rail. Fig. 40 (3)
- ▶ Insert right rail. Fig. 40 (4)
- ▶ Remove drawer to the front. Fig. 40 (5)

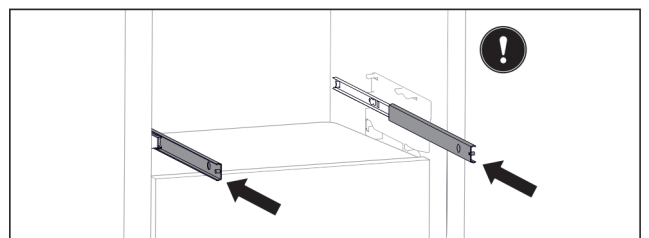

Fig. 41

- If the rails are not yet fully inserted after removing the drawer:
- ▶ Push rails in completely.

Inserting drawer

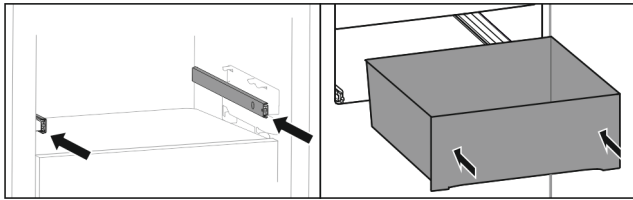

Fig. 42

- ▶ Slide rails in.
- ▶ Place drawer on rails.
- ▶ Slide in drawer to the back.

7.7 EasyFresh-Safe cover

You can remove the compartment cover for cleaning.

7.7.1 Removing the compartment cover

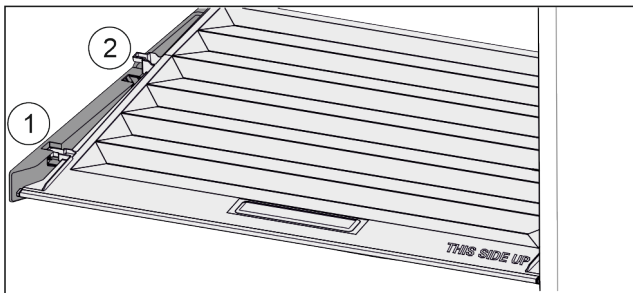

Fig. 43

When the drawers are removed:

- ▶ Pull the lid up at the front to the opening in the retaining parts Fig. 43 (1).
- ▶ Lift from the back and pull it up and out Fig. 43 (2).

7.7.2 Inserting the compartment cover

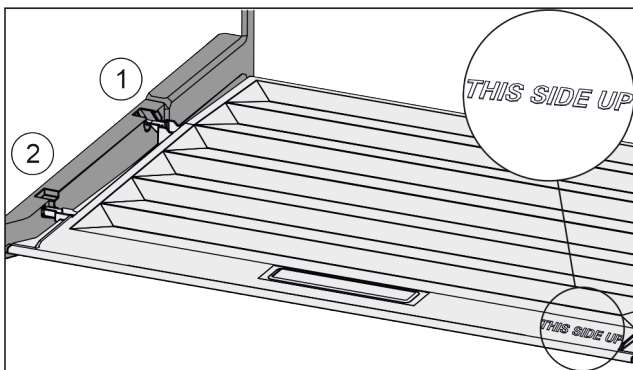

Fig. 44

If the text THIS SIDE UP points upwards:

- ▶ Insert the lip of the cover over the opening of the rear bracket Fig. 44 (1) and click into place Fig. 44 (2).
- ▶ Position the cover where you want it (see 7.8 Adjusting the moisture levels).

7.8 Adjusting the moisture levels

You can adjust the moisture in the drawer yourself by adjusting the compartment cover.

The compartment lid is attached to the drawer and can be hidden by a shelf or additional drawers.

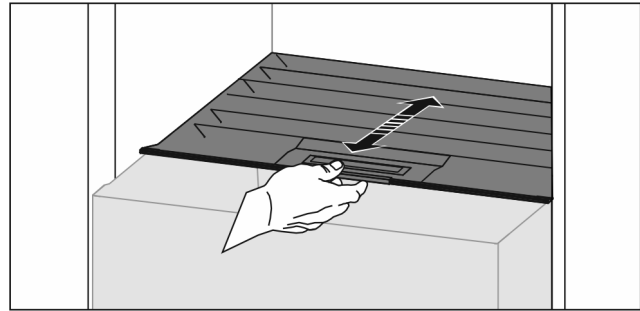

Fig. 45

Low air humidity

- ▶ Open the drawer.
- ▶ Slide the compartment cover forwards.
- ▷ With the drawer closed: Gap between the cover and the compartment.
- ▷ The air moisture in the Safe decreases.

High air moisture

- ▶ Open the drawer.
- ▶ Slide the cover back.
- ▷ With the drawer closed: The cover seals the compartment.
- ▷ The air moisture in the Safe increases.
- If there is too much moisture in the compartment:
 - ▶ Choose the setting "low air moisture".
- or-
- ▶ Remove any excess moisture with a cloth.

7.9 Glass shelves

You can remove the glass shelves under the drawers for cleaning.

You can remove the glass shelves under the drawers to use VarioSpace.

7.9.1 Removing / inserting the glass shelf

Make sure that the following requirements are fulfilled:

- Glass shelf under the drawer: The drawer has been removed. (see 7.6 Drawers)

Removing glass shelf

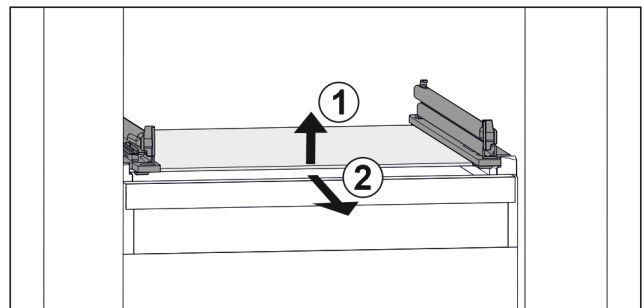

Fig. 46 Example illustration of glass shelf

- ▶ Lift glass shelf at the front. Fig. 46 (1)
- ▶ Take out glass shelf to the front. Fig. 46 (2)

Features

Inserting glass shelf

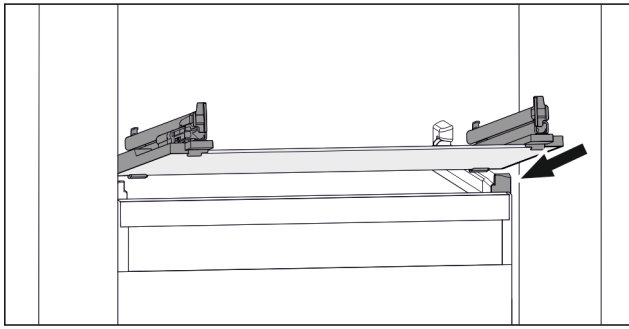

Fig. 47 Example illustration of glass shelf

- ▶ Position glass shelf at an angle behind the stoppers. (see Fig. 474)
- ▶ Lower glass shelf.
- ▶ Slide in glass shelf to the back.

7.10 IceMaker*

The IceMaker produces ice cubes with the water tank in the fridge section. The water tank can also be used to provide cooled drinking water.

The IceMaker will produce ice cubes for household use only.

Ensure that the following conditions are met:

- IceMaker is cleaned (see 8 Maintenance) .
- The water tank is clean (see 8 Maintenance) .
- IceMaker drawer is cleaned.
- IceMaker drawer is fully inserted.

7.10.1 Fill the water tank



WARNING

Unclean water!
Contaminants.

- ▶ Only fill the water tank with potable water.
- ▶ If you are not using the IceMaker: Empty the water tank. (see 8.4.5 Cleaning the IceMaker*)

NOTICE

Sugar-content liquids!
Damage to IceMaker.

- ▶ Only fill with cold drinking water.

Note

Using filtered, decarbonised water ensures the best-tasting drinking water for your ice cubes.

This water quality can be achieved using a table water filter of the kind available in trade retail outlets.

- ▶ Always fill the water tank only with filtered, decarbonised drinking water.

The IceMaker is supplied with water from the water tank (see 1 Appliance at a glance) .

If the water tank is empty, the following reminder appears

on the display  .

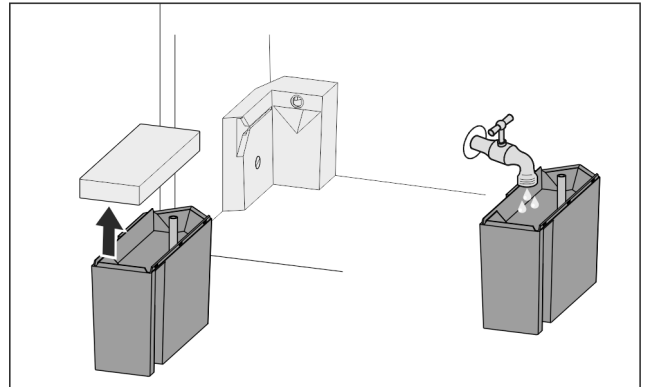

Fig. 48

- ▶ Pull the water tank towards you and out.
- ▶ Remove the lid.
- ▶ Fill with drinking water.
- ▶ Put the lid on.
- ▶ Insert the water tank into the brackets and slide in all the way.

7.10.2 Producing ice cubes

The volume depends on the freezing temperature. The colder the temperature, the more ice cubes the system can produce in a certain time period.

After the IceMaker is turned on for the first time, it can take up to 24 hours for the first ice cubes to be made.

- ▶ Activate the IceMaker function (see 6.2 Control concept) .
- ▶ To make a high number of ice cubes: Activate the MaxIce function (see 6.2 Control concept) .
- ▶ To make a high number of ice cubes: Move the divider in the IceMaker drawer or remove it completely.*
- ▶ Distribute the ice cubes evenly in the drawer to increase the capacity.
- ▶ Closing the drawer: IceMaker starts making ice cubes again automatically.

Note

When a certain level is reached in the IceMaker drawer, it stops producing ice cubes. The IceMaker does not fill the drawer all the way to the top.

7.10.3 Using the drawer with the IceMaker deactivated

If you deactivate the IceMaker, then you can use the entire IceMaker drawer as a freezer drawer.

- ▶ Deactivate IceMaker. (see 6.3.12.2 Deactivating IceMaker)

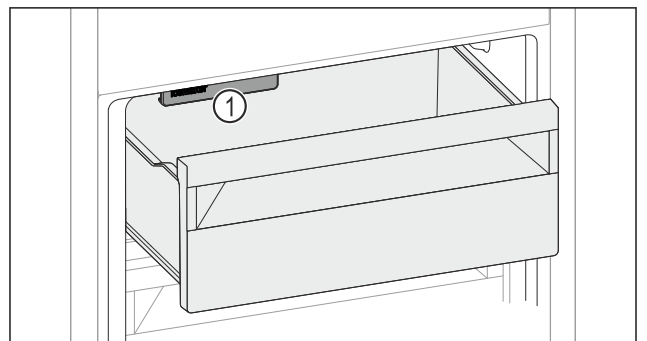

Fig. 49

- ▶ Place food in drawer.
If you put food in the left side of the drawer:
- ▶ Watch out for the IceMaker Fig. 49 (1).

7.11 VarioSpace

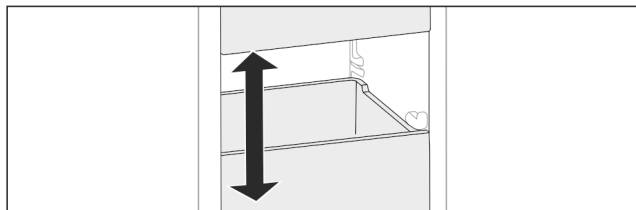

Fig. 50

You can remove drawers and glass panels from your appliance. This provides more room for large food items such as poultry, joints of meat, large game, and tall baked products. You can then freeze these items whole for later preparation.

- ▶ Note the weight limits on the drawers and glass panels (see 9.1 Technical specifications).

7.12 Accessories

7.12.1 Bottle holder

Using the bottle holder

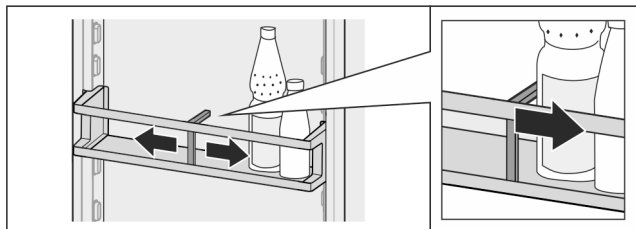

Fig. 51

- ▶ Push the bottle holder onto the bottles.
- ▷ The bottles are prevented from falling over.

Removing the bottle holder

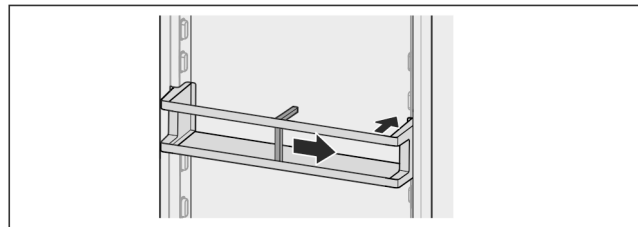

Fig. 52

- ▶ Move the bottle holder all the way to the right.
- ▶ Push the bottle holder to the back to remove.

7.12.2 Flexible ice compartment divider*

The IceMaker's ice cube drawer has a flexible ice compartment divider. This allows you to store larger quantities of ice cubes or additional food items as needed. You can move or remove the ice compartment divider.

Moving in the flexible ice compartment divider

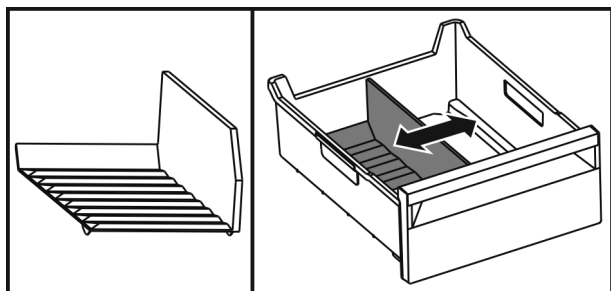

Fig. 53 Example illustration of the ice compartment divider

- ▶ Move the ice compartment divider to the desired position.

Removing the flexible ice compartment divider

Make sure that the following requirements are fulfilled:

- ❑ Ice cube drawer is removed. (see 7.6 Drawers)

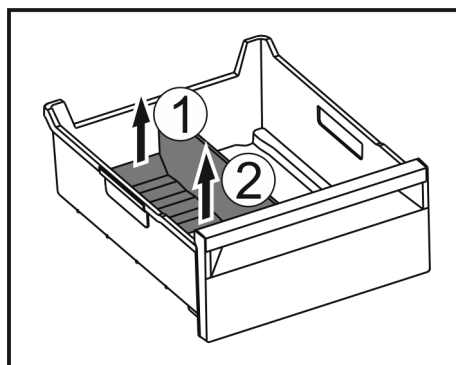

Fig. 54

- ▶ Lift the rear part of the ice compartment divider. Fig. 54 (1)
- ▶ Remove the ice compartment divider upwards. Fig. 54 (2)

Putting in the flexible ice compartment divider

Make sure that the following requirements are fulfilled:

- ❑ Ice cube drawer is removed. (see 7.6 Drawers)

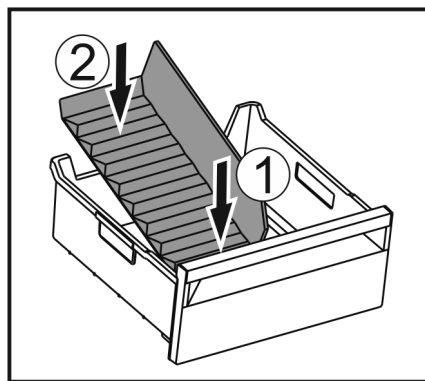

Fig. 55

- ▶ Insert the front part of the ice compartment divider. Fig. 55 (1)
- ▶ Lower the rear part of the ice compartment divider to the drawer bottom. Fig. 55 (2)

8 Maintenance

8.1 FreshAir carbon filter

The FreshAir carbon filter is in the compartment above the fan.

It guarantees the best air quality.

- ❑ Replace the carbon filter every 6 months. When the reminder is set, a message on the display prompts you to change it.
- ❑ The carbon filter can be disposed of with the regular household waste.

Note

FreshAir activated charcoal filters can be purchased from the Liebherr-Hausgeräte store at home.liebherr.com/shop/de/deu/zubehor.html.

Maintenance

8.1.1 Removing the FreshAir carbon filter

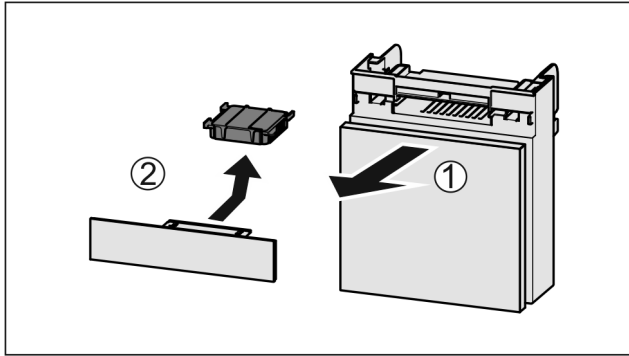

Fig. 56

- ▶ Pull out the compartment Fig. 56 (1).
- ▶ Remove the carbon filter Fig. 56 (2).

8.1.2 Inserting the FreshAir carbon filter

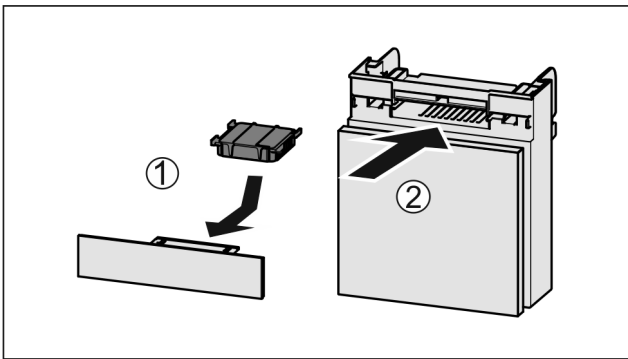

Fig. 57

- ▶ Insert the carbon filter as shown in the diagram Fig. 57 (1).
 - ▷ The carbon filter clicks into place.
 - ▷ If the carbon filter is pointing downwards:
 - ▶ Push the compartment in Fig. 57 (2).
 - ▷ The carbon filter is now ready for use.

8.2 Disassembling / assembling pull-out systems

8.2.1 Notes on disassembly

You can disassemble some of the pull-out systems for cleaning. Your appliance can contain a variety of pull-out systems.

The following pull-out systems can be disassembled or cannot be disassembled:

Pull-out system	can be disassembled / cannot be disassembled
Drawer on appliance base or glass shelf	cannot be disassembled
Drawer on rails	cannot be disassembled
Fully extendible*	cannot be disassembled*
Partial pull-out fridge compartment*	cannot be disassembled*

8.3 Defrosting the appliance



WARNING

Improper defrosting of the appliance!*
Injuries and damage.

- ▶ Do not use mechanical equipment or other methods to speed up the defrosting process other than those recommended by the manufacturer.
- ▶ Do not use electrical heating or steam-cleaning appliances, naked flames or defroster sprays to defrost.
- ▶ Do not use sharp objects to remove ice.

8.3.1 Defrosting the fridge compartment

Defrosting is performed automatically. The water from the thawing process drains through the outlet and evaporates.

Water drops or a thin layer of frost or ice can form on the back wall; this is a completely normal part of the appliance's function. This must not be removed.*

A layer of frost or ice can form briefly due to the energy-optimised control of the device.*

A layer of frost or ice can form briefly due to the energy-optimised control of the device.*

- ▶ Clean the drain opening regularly (see 8.4 Cleaning the appliance).

8.3.2 Defrosting the freezer compartment with NoFrost*

Defrosting is performed automatically with the NoFrost system. The moisture is deposited on the evaporator, is periodically defrosted and evaporates.

The appliance does not need to be defrosted.

8.3.3 Defrosting the freezer compartment manually*

A layer of frost or ice forms after prolonged use.

The following factors promote the formation of frost or ice:

- The appliance is opened frequently.
- Hot food is put in.

One day before defrosting:

- ▶ Activate SuperFrost (see 6.3 Functions).
- ▷ Frozen goods have a "residual coldness".
- ▶ Switch off the appliance.
- ▶ Pull out the mains plug or switch off the fuse.
- ▶ Wrap the frozen produce in newspaper or blankets and store in a cool place.
- ▶ Place a pan of hot water (not boiling) on the middle shelf.

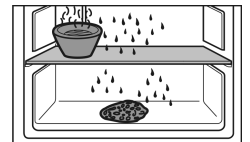

- ▷ This speeds up the defrosting process.
- ▶ Leave the appliance door open during defrosting.
- ▶ Remove loosened pieces of ice.
- ▶ Make sure that there is no melted ice water in the cabinet.
- ▶ Soak up the melted ice water with a sponge or cloth several times as necessary.
- ▶ Clean the appliance (see 8.4 Cleaning the appliance).

8.4 Cleaning the appliance

8.4.1 Ready



WARNING

Danger of electric shock!

- ▶ Remove the refrigerator connector or interrupt the power supply.



WARNING

Risk of fire

- ▶ Do not damage the refrigeration circuit.

- ▶ Empty the appliance.
- ▶ Remove mains connector.

-or-

- ▶ Activate CleaningMode. (see CleaningMode*) *

8.4.2 Cleaning the interior

NOTICE

Improper cleaning!

Damage to the appliance.

- ▶ Only use soft cleaning cloths and ph-neutral all-purpose cleaners.
- ▶ Do not use abrasive sponges or steel wool which may cause scratches.
- ▶ Do not use any sharp or abrasive cleaning agents, nor any that contain sand, chloride or acid.

- ▶ Plastic surfaces: clean by hand with a soft clean cloth, lukewarm water and a little detergent.
- ▶ Metal surfaces: clean by hand with a soft clean cloth, lukewarm water and a little detergent.
- ▶ Drain hole: remove deposits using a thin item (for example a cotton bud).

8.4.3 Cleaning the dry rear panel*

You can remove the dry rear panel for cleaning.

Removing the rear panel

- ▶ Remove all equipment parts.

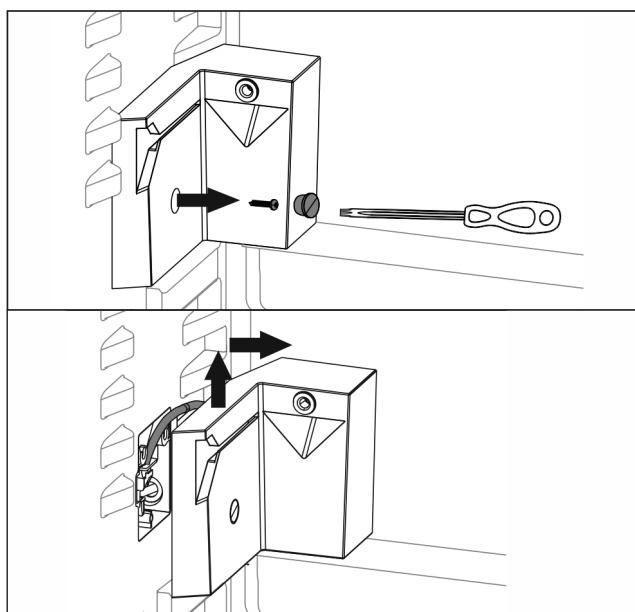

Fig. 58

- ▶ Unscrew the bracket of the water tank with a torx screwdriver.

- ▷ The bracket remains attached to the side panel via various connections and cannot be completely removed.

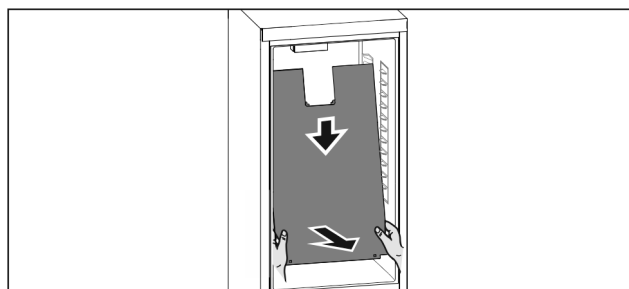

Fig. 59

- ▶ Hold the rear panel with both hands at the bottom and pull downward vigorously at the same time.
- ▶ Pull the rear panel out to the front by the bottom end.
- ▷ The rear panel has been removed.
- If you want to continue operating the appliance with the rear panel removed:
 - ▶ Set the *D-Value* to *D2*. (see D-Value*)

Inserting the rear panel

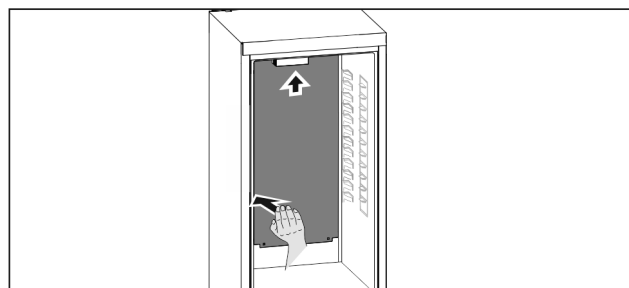

Fig. 60

- ▶ Make sure the appliance is completely empty.
- ▶ Slide in the rear panel from below to the top.
- ▶ Press back vigorously on the left-hand side of the rear panel.
- ▷ The rear panel clicks into place.
- ▶ Screw the water tank bracket firmly in place.
- ▶ Insert the equipment parts.
- ▶ Set the *D-Value* to *D1*. (see D-Value*)

8.4.4 Clean the components

NOTICE

Improper cleaning!

Damage to the appliance.

- ▶ Only use soft cleaning cloths and ph-neutral all-purpose cleaners.
- ▶ Do not use abrasive sponges or steel wool which may cause scratches.
- ▶ Do not use any sharp or abrasive cleaning agents, nor any that contain sand, chloride or acid.

Clean with a soft, clean cloth, lukewarm water and some detergent:

- Door rack
- Shelf
- Dividing shelf*
- VarioSafe*
- EasyFresh-Safe cover
- Drawer
- Please note: Do not remove the magnet on the drawer. The magnet ensures the functionality of the IceMaker.*
- Divider in the IceMaker drawer*

Clean with a damp cloth:

- Retractable rails
- Please note: The grease in the tracks is used for lubrication and must not be removed!

Customer help

Wash in the dishwasher up to 60 °C:

- Bottle rack
- Holder of the dividing shelf
- IceMaker water tank and water tank lid*
- Ice cube tray*
- Ice cube scoop*
- ▶ To disassemble components: see the relevant section.
- ▶ Clean the components.

8.4.5 Cleaning the IceMaker*

There are various options for cleaning the IceMaker.

Cleaning is required in the following cases:

- Initial operation
- If out of use for more than 48 hours.

Ensure that the following conditions are met:

- Water tank is clean and has been filled. (see 7.10.1 Fill the water tank)
- IceMaker drawer is emptied.
- IceMaker drawer is in place.
- The IceMaker is activated. (see 6.2 Control concept)

First use or after a long period of non-use

Clean the IceMaker with the TubeClean function.

- ▶ Place a 1.5 l empty container (max. height 10 cm) into the drawer under the IceMaker.
- ▶ Activate the TubeClean function. (see 6.2 Control concept)
- ▷ The rinse process is prepared (max. 60 min.): Symbol flashes.
- ▷ Water pipes are rinsed: Symbol flashes.
- ▷ Rinsing process is complete: Function turns off automatically.
- ▶ Remove the IceMaker drawer and remove the container.
- ▶ Clean the IceMaker drawer with warm water and a little detergent.
- ▶ Push the IceMaker drawer in.
- ▷ The system starts making ice cubes automatically.
- ▶ Dispose of any ice cubes that were made 24 hours after the first ice cubes.

If cleaning is required

Clean the IceMaker by hand.

- ▶ Remove the IceMaker drawer and clean with warm water and a little detergent.
- ▶ Push the IceMaker drawer in.
- ▷ The system starts making ice cubes automatically.

8.4.6 After cleaning

- ▶ Wipe the appliance and the components dry.
- ▶ Connect and switch on the appliance.
- ▶ Activate SuperFrost (see 6.3 Functions) . The temperature is cold enough:
- ▶ Place the food inside.
- ▶ Repeat cleaning regularly.

9 Customer help

9.1 Technical specifications

Temperature range	
Cooling	2 °C to 9 °C
Freeze	-26 °C to -15 °C

Maximum freezer quantity / 24 hrs	
Freezer compartment	See the type plate under "Freezer goods ... /24 hours"

Maximum component capacity			
Features	Appliance width 550 mm (see installation instructions, appliance dimensions)	Appliance width 600 mm (see installation instructions, appliance dimensions)	Appliance width 700 mm (see installation instructions, appliance dimensions)
Drawer on glass shelf (see 7.6.1 Drawer on appliance base or glass shelf)	12 kg	15 kg	--

Maximum size baking tray	
Width	466 mm
Depth	386 mm
Height	50 mm

Ice cube production with IceMaker*	
Ice cube production / 24 h	At a temperature of -18 °C: 1.2 kg of ice cubes
Maximum ice cube production / 24 hours	With the MaxIce function on: 1.5 kg of ice cubes

Lighting	
Class ¹	Light source
This product contains one or more energy efficiency class F light sources.	LED

1 The appliance may contain light sources with different energy efficiency classes. The lowest energy efficiency class is indicated.

9.2 Operating noises

The appliance makes different noises when it is on.

- At **higher temperatures** the appliance uses less energy but works for longer. It is **quieter**.
- At **lower temperatures** the food is cooled faster. It is **louder**.

Examples:

- Functions on (see 6.3 Functions)
- Fan running
- Food recently added
- High ambient temperature
- Door open for a while

Noise	Possible cause	Type of noise
Bubbling and splashing	Coolant flowing into the cooling circuit.	Normal operating noise

Noise	Possible cause	Type of noise
Hissing	Coolant sprays into the cooling circuit.	Normal operating noise
Humming	The appliance is cooling. The volume depends on the cooling output.	Normal operating noise
Suction noises	Soft-closing door is being opened and closed.	Normal operating noise
Humming and rustling	The fan is running.	Normal operating noise
Clicking	Components are switched on and off.	Normal switching noise
Rattling or humming	Valves or flaps are working. The water tank pump is on.*	Normal switching noise

Noise	Possible cause	Type of noise	Lifting
Rattling	Components, items inside the appliance	Defective noise	Secure components. Leave enough space between the items.

9.3 Technical fault

Your appliance is designed and built to ensure it works reliably and has a long service life. In the unlikely event that a fault occurs during operation, please check whether it is due to an operating error. If so, you will be charged for the callout and repair costs even if it falls within the warranty period.

You can fix the following faults yourself.

9.3.1 Appliance function

Noise	Possible cause	Type of noise	Lifting
Vibration	Improper installation	Defective noise	Check the installation. Level the appliance.

Defect	Cause	Remedy
The appliance is not working.	→ The appliance is not switched on.	▶ Switch the appliance on.
	→ The power plug is not properly plugged into the socket.	▶ Check the power plug.
	→ There is something wrong with the power outlet fuse.	▶ Check the fuse.
	→ Power cut	▶ Keep the appliance closed. ▶ Protecting food: Lay freezer packs on top of the food or use another freezer if the power is off for a prolonged period. ▶ Do not re-freeze defrosted food,
	→ The appliance plug does not fit the appliance properly.	▶ Check the appliance plug.
Temperature is not cold enough.	→ The appliance door is not closed properly.	▶ Close the appliance door.
	→ Not enough ventilation.	▶ Keep ventilation grille clear, and clean it.
	→ The ambient temperature is too high.	▶ Solution: (see 1.4 Appliance range of use) .
	→ The appliance was opened too many times or for too long.	▶ Wait to see if the required temperature corrects itself. If not, contact Customer Service (see 9.4 Customer Services) .
	→ Too much fresh food was placed inside without SuperFrost.	▶ Solution: (see SuperFrost)
	→ The temperature is set incorrectly.	▶ Turn down the temperature and check after 24 hours.
	→ The appliance is too close to a heat source (oven, radiator, etc).	▶ Move the appliance or the heat source.

Defect	Cause	Remedy
	→ The appliance was not correctly installed in the recess.	▶ Check if the appliance was installed correctly and that the door closes properly.
The door seal is defective or needs to be replaced for another reason.	→ The door seal can be replaced. It can be replaced without the need for special tools.	▶ Contact Customer Services (see 9.4 Customer Services) .
The appliance builds up too much ice or condensation.	→ The door seal may have slipped out of its groove.	▶ Check that the door seal is well fitted in the groove.

9.3.2 Features

Defect	Cause	Remedy
The IceMaker is not producing ice cubes.*	→ The IceMaker is not on.	▶ Activate the IceMaker.
	→ The drawer of the IceMakers is not connected properly.	▶ Push the drawer in correctly.
	→ The water tank is not pushed in properly.	▶ Push the water tank in.
	→ There is not enough water in the water tank.	▶ Fill the water tank.
The internal light does not come on.	→ The appliance is not switched on.	▶ Switch the appliance on.
	→ The door was open for longer than 15 minutes.	▶ Interior lighting turns off automatically after approx. 15 min. with the door open.
	→ The LED interior light is faulty or the lid is damaged.	▶ Contact customer service (see 9.4 Customer Services) .

9.4 Customer Services

First check if you can fix the error yourself (see 9 Customer help) . If you can't, contact Customer Services.

Please refer to the enclosed "Liebherr-Service" brochure for the address.



WARNING

Unprofessional repair!
Injuries.

- ▶ Have any repairs and action - not expressly specified - on the appliance and mains cable carried out by service personnel only. (see 8 Maintenance)
- ▶ A damaged mains cable may only be replaced by the manufacturer, the manufacturer's Customer Service or a similarly qualified person.
- ▶ In the case of appliances with an IEC connector, the change may be made by the customer.

9.4.1 Contact Customer Services

Make sure you have the following appliance data at the ready:

- Appliance name (model and index)
- Service no. (Service)
- Serial no. (S no.)
- ▶ Look up the appliance information on the display (see Info) .

-or-

- ▶ Referring to appliance info on the nameplate (see 9.5 Model plate) .
- ▶ Note down the appliance information.
- ▶ Notify Customer Services of the following: Give us the appliance data.
 - ▷ This will help us to provide you with a faster, more accurate service.
- ▶ Follow any further instructions given by Customer Services.

9.5 Model plate

The model plate is behind the drawers on the inside of the appliance.

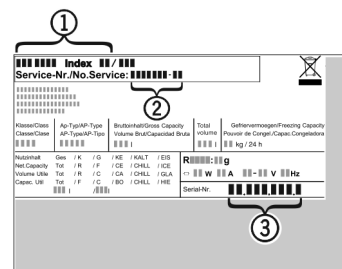

Fig. 61

- (1)** Appliance description **(3)** Serial no.
- (2)** Service no.
- ▶ Note the data on the model plate.

10 Shutting down

- ▶ Empty the appliance.
- ▶ Turn off the IceMaker.*
- ▶ Turn off the appliance.
- ▶ Remove mains connector.
- ▶ Remove appliance connector if required: Remove and move from left to right at the same time.
- ▶ Clean the appliance (see 8.4 Cleaning the appliance).
- ▶ Leave the door open to avoid bad smells building up.

11 Disposal

11.1 Preparing appliance for disposal



Li-Ion

Liebherr uses batteries in some of its appliances. In the EU, for environmental reasons, legislation obliges the end user to remove these batteries before disposing of old appliances. If your appliance contains batteries, a corresponding notice is attached.

Lamps If you can remove the lamps yourself without destroying them, also remove these before disposal.

- ▶ Take the appliance out of operation.
- ▶ Appliances with batteries: remove the batteries. For description, see **Maintenance** chapter.
- ▶ If possible: remove lamps without destroying them.

11.2 Disposing of the appliance in an environmentally friendly manner



The appliance still contains valuable materials and must be disposed of separately from unsorted municipal waste.



Li-Ion



Li-Ion

Dispose of batteries separately from the old appliance. To do this, you can return the batteries free of charge to retailers as well as recycling centres and collection centres for recyclable materials.

Lamps Dispose of removed lamps via the respective collection systems.

For Germany: You can dispose of the appliance free of charge via the class 1 collection containers at the local recycling and recyclable material collection centres. When purchasing a new fridge/freezer, if the sales area > 400 m², retailers will also take back the old appliance free of charge.



WARNING

Leaking coolant and oil!

Fire. The coolant contained in the appliance is eco-friendly, but also flammable. The oil contained in the appliance is flammable. Escaping coolant and oil can ignite if the concentration is high enough and in contact with an external heat source.

- ▶ Do not damage the pipelines of the coolant circuit and the compressor.

- ▶ Transport the appliance without damaging it.
- ▶ Dispose of batteries, lamps and the appliance according to the above specifications.



home.liebherr.com/fridge-manuals

EN Integrated fridge/freezer

Issue date: 20230323

Part number index: 7088256-00

Liebherr-Hausgeräte GmbH
Memminger Straße 77-79
88416 Ochsenhausen
Deutschland